

Power Quality and Integration of Wind Farms in Weak Grids in India

**Poul Sørensen and Peter Hauge Madsen, Risø, Denmark
Anders Vikkelsø and K. Kølbaek Jensen, DEFU, Denmark
K.A. Fathima, A.K. Unnikrishnan and Z.V. Lakaparampil, ER&DCI(T), India**

Abstract This is the final report of a joint Danish and Indian project "Power Quality and Integration of Wind Farms in Weak Grids". The power quality issues have been studied and analysed with the Indian conditions as a case. On the basis of meetings with Danish wind turbine industry, Indian electricity boards, nodal agencies, wind turbine industry and authorities, the critical power quality aspects in India have been identified. Measurements on selected wind farms and wind turbines have quantified the power quality, and analyses of power quality issues, especially reactive power compensation, have been performed. Based on measurements and analyses, preliminary recommendations for grid integration of wind turbines in weak grids have been formulated.

The Danish Ministry of Energy has funded the Danish part of the work in the contract ENS-1363/98-0024.

The Indian Ministry of Non-Conventional Energy Sources (MNES) has funded the Indian part of the work. Ref: 52/164/97/WE/PG dated 7/10/98

Reviewed by

Lars Henrik Hansen

Henrik Bindner

ISBN 87-550-2676-1
ISBN 87-550-2678-8 (Internet)
ISSN 0106-2840

Information Service Department, Risø, 2000

Contents

Preface 5

1 Introduction 6

2 Critical power quality issues 6

- 2.1 General 6
- 2.2 Grid availability and capacity 7
- 2.3 Reactive power compensation 7
- 2.4 Voltage unbalance 7
- 2.5 Voltage ranges 8
- 2.6 Frequency range 8
- 2.7 Harmonics and interharmonics 8
- 2.8 Voltage fluctuations 8
- 2.9 Islanding and overcompensation 8

3 Power quality data 9

- 3.1 General 9
- 3.2 Grid capacity 9
 - 3.2.1 Tamil Nadu 9
 - 3.2.2 Gujarat 10
- 3.3 Measurement setup 11
 - 3.3.1 Measurement equipment 11
 - 3.3.2 Measurement points in Tamil Nadu 12
 - 3.3.3 Measurement points in Gujarat 12
- 3.4 Measurement results 13
 - 3.4.1 Reactive power 13
 - 3.4.2 Voltage and current unbalance 17
 - 3.4.3 Voltage ranges and grid availability 19
 - 3.4.4 Frequency range 21
 - 3.4.5 Harmonics and interharmonic distortion 22
 - 3.4.6 Voltage fluctuations 27
- 3.5 Summary 27

4 Power factor improvement schemes 28

- 4.1 General 28
- 4.2 Capacitor compensation 28
- 4.3 Synchronous Condenser 29
- 4.4 Thyristor Controlled Reactors 29
- 4.5 Inverters with force commutated switches 29

5 Induction generators interaction with weak grid 29

- 5.1 Voltage variations 30
- 5.2 Frequency variations 31
- 5.3 Voltage unbalance 32

6 Capacitor compensation in wind turbines 33

- 6.1 General 33
- 6.2 No-load compensation 33
- 6.3 Influences on power factor 34

6.3.1	Generator	34
6.3.2	Capacitors	35
6.3.3	Transformer	35
6.3.4	Steady state voltage	38
6.3.5	Frequency	39
6.3.6	Voltage and current unbalance	40
6.3.7	Summary of effects	40
6.4	The obtainable monthly average power factor	41
6.5	Requirements for a shunt connected power capacitor	42
6.5.1	General	42
6.5.2	Overvoltages	42
6.5.3	Current limits	43
6.5.4	Temperature limits	43
6.5.5	Harmonic and interharmonic disturbances	44
6.6	Simulation of overvoltages	45
6.6.1	Cases with overvoltages	45
6.6.2	Simulation model	45
6.6.3	Connecting the capacitor bank to the grid	46
6.6.4	Disconnecting the capacitor bank from the grid	47
6.6.5	Disconnecting the capacitor bank – island situation	48
6.7	Summary	50
6.7.1	General	50
6.7.2	Power factor	50
6.7.3	Overvoltages	50
6.7.4	Harmonics	51

7 ASVC based compensation 51

7.1	General	51
7.2	Control strategy	52
7.3	Connection of ASVC with the Wind farm	53
7.4	Summarised advantages	54

8 Conclusions and recommendations 54

8.1	Conclusions	54
8.2	Recommendations for grid connection	56
8.3	Recommendations for wind turbines	56
8.4	Operation and maintenance	57

Acknowledgement 57

References 57

Appendices 59

Appendix A	Conditions in Indian states	59
Appendix B	Parameters for simulation model	65

Preface

This report describes the joint Danish and Indian project on Power Quality and Integration of Wind Farms in Weak Grids. The joint project has been funded in part by the Danish Energy Agency and by the Ministry of Non-Conventional Energy Sources, MNES, Government of India. Risø National Laboratory and Danish Utilities Research Institute DEFU have participated from Denmark, and the Electronics Research and Development Centre ER&DCI(T) has participated from India.

1 Introduction

This report describes the joint Danish and Indian project on Power Quality and Integration of Wind Farms in Weak Grids. The joint project has been funded in part by the Danish Energy Agency and the Ministry of Non-Conventional Energy Sources (MNES) in India. Risø National Laboratory and Danish Utilities Research Institute DEFU has participated from Denmark, and the Electronics Research and Development Centre ER&DCI(T) has participated from India.

The background for the project is the increasing utilisation of wind energy in the power systems. In Europe, the wind energy penetration in the power systems is often highest in rural areas with weak grids. The Danish government plans to utilise wind energy in large scale by installation of large off-shore wind farms. In India, the wind energy is concentrated in rural areas with a very high penetration. In these cases, the wind power has an increasing influence on the power quality on the grids.

Another aspect is the influence of weak grids on the operation of wind turbines. In India, grid abnormalities reduces the financial attractiveness of wind farm investments as described by Rajsekhar et.al. [1].

In the present project, the power quality issues have been studied with the Indian conditions as a case, and preliminary guidelines for grid integration of wind turbines in weak grids have been formulated. The activities in the project are detailed below:

- Identification of critical power quality issues for large wind farms connected to utility grids in India.
- Collection of data from the wind farms related to all aspects of power quality problems in India, and analyses of the data.
- Study of solutions to improve the power quality, and identification of the most promising technical and economic options for improving the power quality.
- Recommendation of guidelines for connecting wind farms to weak grids.
- Presentation of results to the interested parties. In Denmark, the results were presented on a seminar, and in India, the results were presented on a workshop on Wind Power Generation and Power Quality Issues.

2 Critical power quality issues

2.1 General

This section states the critical power quality issues related to integration of wind farms in weak grids in India. The issues have been identified during a field study tour in India in the period 26 October – 10 November 1998. During the field study, a team represented by Risø, DEFU and ER&DCI(T) met with government officials, electricity boards, nodal agencies, wind turbine manufacturers and wind farm owners in the Indian states Gujarat, Maharastra, Andhra Pradesh

and Tamil Nadu. To prepare the field study in India, Risø and DEFU teams visited Danish manufacturers 5-6 October 1998.

The field study tour has identified the following issues to characterise the power quality:

1. Grid availability and capacity
2. Reactive power
3. Voltage unbalance
4. Voltage ranges
5. Frequency range
6. Harmonics and interharmonics
7. Voltage fluctuations
8. Islanding and overcompensation

Of these, reactive power is at present the most important parameter for the electricity boards in India, while grid availability, frequency range, voltage unbalance and voltage range are the primary parameters influencing the wind turbine operation.

A detailed description of the field study is given in the Field Study report [2]. Appendix A describes the conditions in 4 states in India, first issued in the Field Study Report.

2.2 Grid availability and capacity

The wind farm development in India has been very intensive in the early nineties. The electricity boards were not capable to follow-up on that development with the required grid reinforcements.

The major weakness has been the evacuation capacity. As a consequence of insufficient evacuation capacity, the wind farms have regularly been disconnected from the grid during the high wind seasons. Outages due to insufficient evacuation capacity have occurred in the Lamba region in Gujarat and in the Muppandal area in Tamil Nadu.

Also the capacity of the substations has influenced the grid availability in the wind farms. In Muppandal, wind farm feeders have been disconnected regularly in the high wind season due to insufficient substation transformer capacity.

2.3 Reactive power compensation

The majority of wind turbines installed in India are converting the mechanical power to electricity through directly connected induction generators. These induction generators require reactive power from the grid for excitation. The loads on the power systems in India also consume a significant reactive power, mainly due to agricultural pumps.

The resulting reactive power demand causes losses in the transmission. In Tamil Nadu, the reactive power consumption results in so poor a power factor, that it reduces the capacity of the power stations. This is a critical issue, because the available power station capacity is insufficient to supply the peak demand. Finally, excessive reactive power consumption can be critical for the stability of the power system.

2.4 Voltage unbalance

Single wind turbines or smaller groups of wind turbines have been connected to existing rural load feeders in some areas in India. The electricity boards practice

load shedding on individual phases during peak load periods. The load shedding causes significant voltage unbalance, with tripping of the wind turbines as a result.

2.5 Voltage ranges

According to the electricity board, the variations in the steady state voltage is in the range from + 5% to –15% at the wind turbine terminals in the wind farms in Tamil Nadu. Too low voltages can cause the relay protections to trip the wind turbines.

The steady state voltage also influences the losses in the induction generators. For low voltages, the no-load losses decrease slightly due to reduced iron losses, whereas the full-load losses (i.e. losses at rated power) increase due to increased currents in the generator windings.

2.6 Frequency range

According to electricity boards and manufacturers, the grid frequency in India can vary from 47 to 51.5 Hz. Most of the time, the frequency is below the rated 50 Hz. For wind turbines with induction generators directly connected to the grid, the rotor speed and thus the aerodynamic performance of the wind turbine will be modified by the frequency.

2.7 Harmonics and interharmonics

The emission of harmonic and interharmonic currents from wind turbines with directly connected induction generators has been expected to be negligible in service.

Wind turbines connected to the grid through power converters however emit harmonic and/or interharmonic currents and contribute to the voltage distortion. Inverters based on new technologies have a limited emission of harmonics at lower frequencies compared to the converters used in the first generation of variable speed wind turbines. Instead they produce interharmonics at higher frequencies which are easier to filter than at lower frequencies.

2.8 Voltage fluctuations

Fluctuations in the voltage supplied to consumers may, depending on the frequency and the amplitude of the fluctuations, cause public annoyance due to flicker in the illumination from lamps. The power from wind turbines is fluctuating, and therefore the wind turbines contribute to the voltage fluctuations in the grid.

Fluctuations in the voltage may in extreme conditions trigger a voltage collapse, as a voltage drop causes increased reactive power consumption, which feeds back as an increased voltage drop.

2.9 Islanding and overcompensation

Most electricity boards set requirements to the average power factor for the wind farms and have introduced penalties for excessive reactive power consumption. The penalties may encourage the owners of wind turbines with di-

rectly connected induction generators to install additional capacitors. Overcompensation with capacitors may cause islanding with rapidly increasing voltages in the island grid.

3 Power quality data

3.1 General

This section presents grid data and measurements from the wind farms related to power quality problems in India. The measurements are compared to Indian and European standards for power quality.

The grid data has been collected during the field study mentioned in section 2.1. The measurements have been logged by Risø and ER&DCI(T) teams 5-12 May 1999 in Muppandal, Tamil Nadu and 28 June – 2 July 1999 in Lamba and Dhank, Gujarat. Moreover, ER&DCI(T) teams have logged data in Muppandal in August and October 1999.

The main measurement results have been presented in a paper by P.Sørensen et. al. [3] to the Workshop in India. This section gives a more detailed description of the measurements.

3.2 Grid capacity

The wind energy development in India has slowed down in the late nineties. The slower development has enabled the utilities to develop the grid capacity to an acceptable level. During the project, the grid capacity in two states, Tamil Nadu and Gujarat, have been studied. Tamil Nadu and Gujarat are the two states in India with the largest installed capacity of wind energy.

3.2.1 Tamil Nadu

The total installed wind energy capacity in Tamil Nadu is 720 MW. 386 MW of this capacity are installed in the Muppandal area. The grid in the Muppandal area is shown in Figure 1.

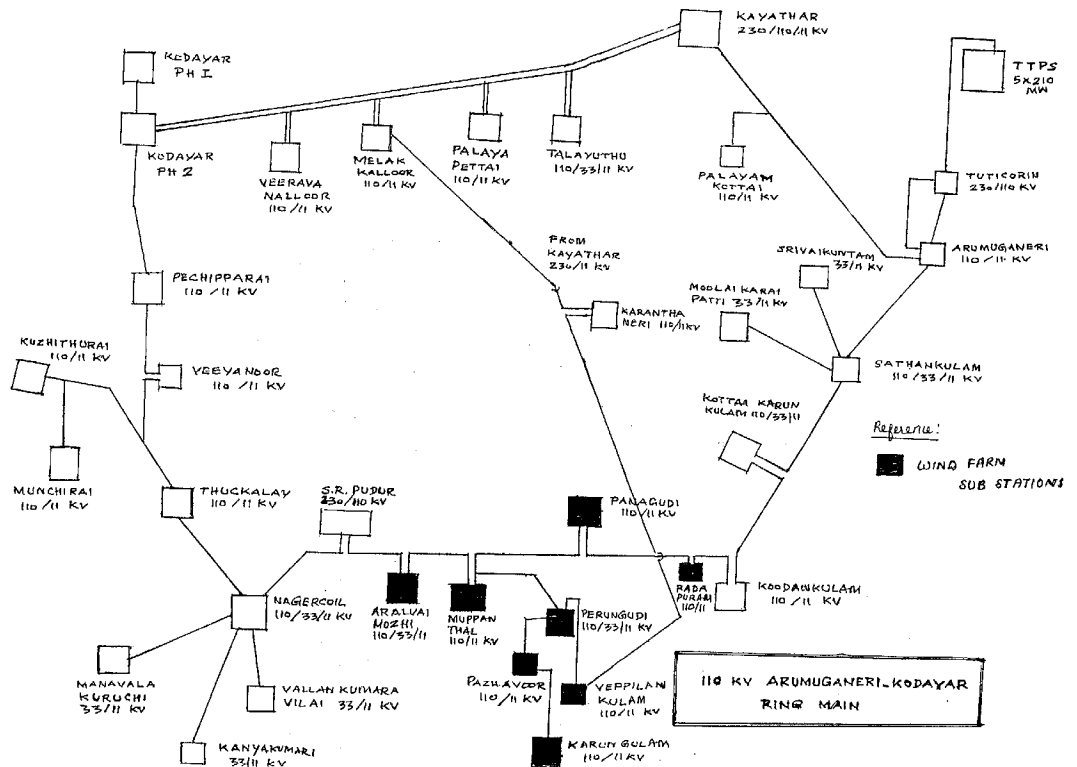

Figure 1. The 110 kV ring mains in Muppandal, Tamil Nadu, drawn by an engineer in the TNEB Muppandal office.

The capacity of the ring mains connection to the 230 kV grid in Kayathar is only 200 MVA. This insufficient evacuation has caused many outages during the windy seasons. To overcome these problems, Tamil Nadu Electricity Board, TNEB, has installed a new 230 kV evacuation line with 100 MVA capacity.

3.2.2 Gujarat

The state of Gujarat has installed 166 MW wind turbine capacity. 92 MW are connected to 3 dedicated wind farm substations along the Porbandar coastal line. This coastal area was hit by a cyclone in June 1998, which damaged approximately 40 MW of the 92 MW, as well as the transmission lines.

The 3 wind farm substations are owned by the Gujarat Development Agency, GEDA. They are connected to the Gujarat Electricity Board, GEB, 132/66 kV substation through a 25 km transmission line as illustrated in Figure 2.

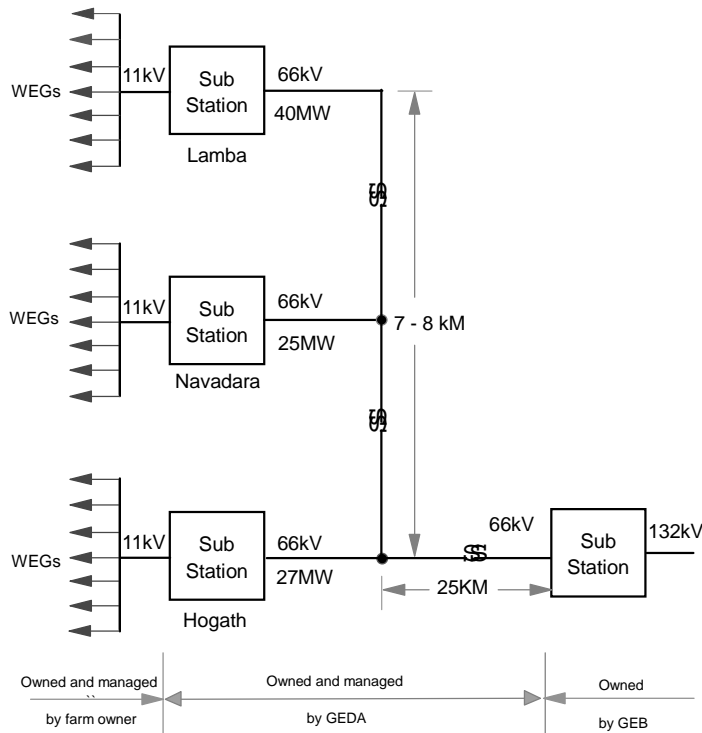

Figure 2. Wind farms and substations on the coastal lines of Porbandar, Gujarat. Dedicated lines for evacuation and no tapping for rural distribution.

The evacuation capacity from the coastal region has also been insufficient. At the moment, the transmission lines have been re-established. With a large part of the wind turbines still not repaired, the evacuation capacity is sufficient at the moment.

3.3 Measurement setup

3.3.1 Measurement equipment

The measurements are taken with a Voltech PM3000A power analyser. The power analyser is connected with a serial link to a Laptop PC, which controls the power analyser and logs data to disk.

The first measurements in Muppandal in May 1999 were taken with the Voltech power supplied directly from the grid in the substations. This prevented a reliable measurement of grid outages, because it was not possible to distinguish between grid outages and communication errors between the laptop and the Voltech. As a consequence, a uninterruptable power supply (UPS) was purchased, and the following measurements in Gujarat June/July and Muppandal August/October were done with the Voltech supplied by the UPS.

The power analyser measures 3 phases of voltages and currents with 1 MHz sampling rate. Power quality is measured both in substations and in individual wind turbines. The voltage and current inputs to the power analyser are connected differently in these cases:

The measurements in the substations use the existing potential transformers (PTs) and current transformers (CTs) in the stations. The secondary sides of the

PTs are connected directly to the voltage inputs of the power analyser, whereas the currents in the secondary windings of the CTs are measured using mini current clamps, with a bandwidth of 1kHz.

In the wind turbines, the voltages are measured directly on the wind turbine bus bars, and the currents are measured with flexible current clamps, which are wound on the bus bars. The bandwidth of the flexible current clamps is 20 kHz.

3.3.2 Measurement points in Tamil Nadu

In Tamil Nadu, measurements have been taken in 3 different 110/11 kV substations. All 3 substations are located in the Muppandal area, which is the area in India with the most extensive wind energy development.

Each of the 3 selected substations are dominated by a certain type of wind turbines. This makes it possible to use the substation measurements to compare the influence of different wind turbine technologies on the power quality.

Tamil Nadu Electricity Board, TNEB, owns the wind farm substations in Muppandal. Therefore, minor loads are connected to the wind farm substations. Measurements were taken only on the 110 kV side. As a consequence, the measured power quality is dominated by the wind farms, but includes the effect of minor loads.

The first substation is Aralvai. The capacity of this substation is 48 MVA. It collects power only from wind turbines with directly connected induction machines. A manually switched 3.6 Mvar capacitor bank is installed on the 11 kV bus bar in Aralvai.

The second substation is Radhapuram. The capacity of this substation is 32 MVA, which matches the installed 79×410 kW wind turbines. All wind turbines are variable speed controlled, using induction generators connected to the grid through full-scale IGBT based power converters.

The third substation is Karunkulam. The capacity of this substation is 42 MVA. The predominant installation in Karunkulam is variable speed wind turbines with induction generators connected to the grid through thyristor based power converters. Wind turbines with directly connected induction generators are also installed in Karunkulam. A 4.8 Mvar capacitor bank is installed on the 11 kV bus bar in Karunkulam.

Measurements have also been taken in 4 wind turbines, of which 3 are with directly connected induction generators and 1 is with IGBT based power converter.

3.3.3 Measurement points in Gujarat

In Gujarat, measurements have been taken in 2 66/11 kV substations. The wind farm substations in Gujarat are owned by the nodal agency GEDA, and they are dedicated to the wind farms.

Measurements were taken on the 66 kV side as well as on the individual feeders on the 11 kV side.

The first substation in Gujarat is Dhank. The capacity of this substation is 60 MVA, but only 36 MW wind turbine capacity is installed.

The second substation in Gujarat is Lamba. This substation connects wind turbines in the area, where a cyclone caused severe damage to wind turbines and grid installations in June 1998. Before the cyclone, 42 MW wind turbine capacity was installed in Lamba, but while the present measurements took place, only 18 MW wind turbine capacity was in operation.

Measurements have also been taken in 3 individual wind turbines in Lamba, of which 2 are with directly connected induction generators and 1 is with IGBT based power converter.

3.4 Measurement results

3.4.1 Reactive power

The Ministry of Non-conventional Energy Sources, MNES, in India issues Revised Guidelines for Wind Power Projects, published in [4]. These guidelines specify only few technical requirements, but they require a monthly average power factor of minimum 0.85.

The financial institution, Indian Renewable Energy Development Agency (IREDA), has prepared “Technical specifications” for wind power projects submitted for financing [5]. These specifications require a minimum power factor of 0.95 at full load as a condition for financing.

The above mentioned requirements reflect that the reactive power consumption of the wind farms is a major concern for the electricity boards in India. TNEB collects penalties of Rs. 0.1 pr. kvar if the monthly average power factor is less than 0.85, whereas GEB in Gujarat has not introduced penalties so far.

Figure 3 shows 10 minutes average values of the reactive power consumption vs. active power production, measured on the primary side of the 5 selected substations. The installed active power capacity is used as p.u. base for each substation, which enables a comparison of the relative reactive power consumption. Figure 3 includes measurements in the Tamil Nadu substations acquired 5-8 May 1999, whereas the measurements from the two Gujarat substations are acquired during the period 28-30 June 1999.

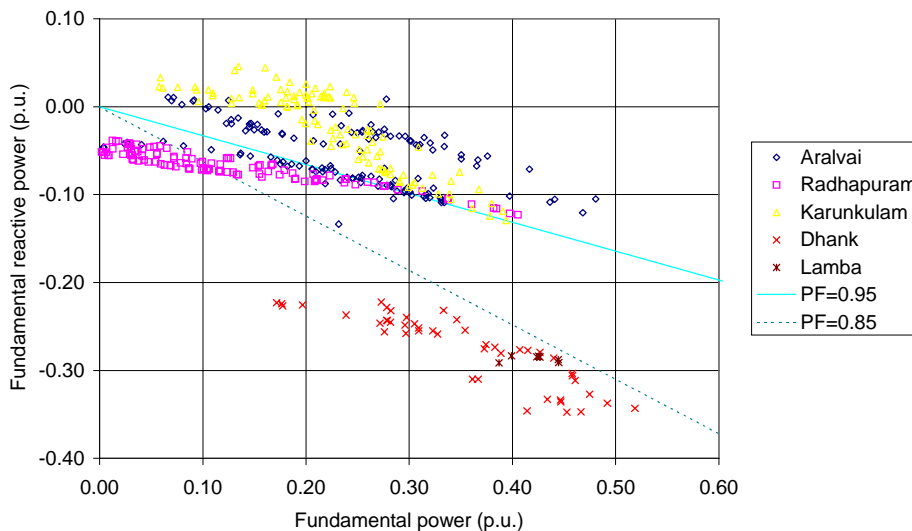

Figure 3. Reactive power consumption on primary sides of substations.

Figure 3 first of all reveals that the reactive power consumption of the selected wind farm substations is much higher in Gujarat than in Tamil Nadu. The better power factors in Tamil Nadu indicate that the penalty has an influence on the power factor. Another reason for the better power factor in Tamil Nadu is that the substations in Tamil Nadu have installed 0.1-0.15 p.u. capacitor banks on the 11 kV busbar to compensate for the reactive power consumption of the wind turbines, except in Radhapuram where all the wind turbines have IGBT

based power converters. In Gujarat, no capacitor banks are installed in the wind farm substations.

The graphs in Figure 3 show some scatter in the measured substation PQ-relations, especially in the Aralvai substation. The scatter is due to changed substation loads, voltage variations and frequency variations.

From the graphs it is seen that the capacitor banks in Karunkulam and Aralvai substations overcompensate the reactive power consumption of the wind farms. The overcompensation at no load is approximately 0.05 p.u. in Karunkulam and 0.02 p.u. in Aralvai.

The maximum no load reactive power consumption is approximately 0.05 p.u. This is similar to the no load consumption in Radhapuram substation with IGBT power converters. The no load reactive power is due to the substation transformers, wind turbines, step-up transformers and consumer loads. In Radhapuram, the wind turbines are probably not consuming reactive power, as they are connected to the grid through power converters.

The reactive power consumption has also been measured feederwise in Dhank and Lamba substations. Figure 4 shows the installed capacity with indication of wind turbine type for each of the 13 feeders in Dhank.

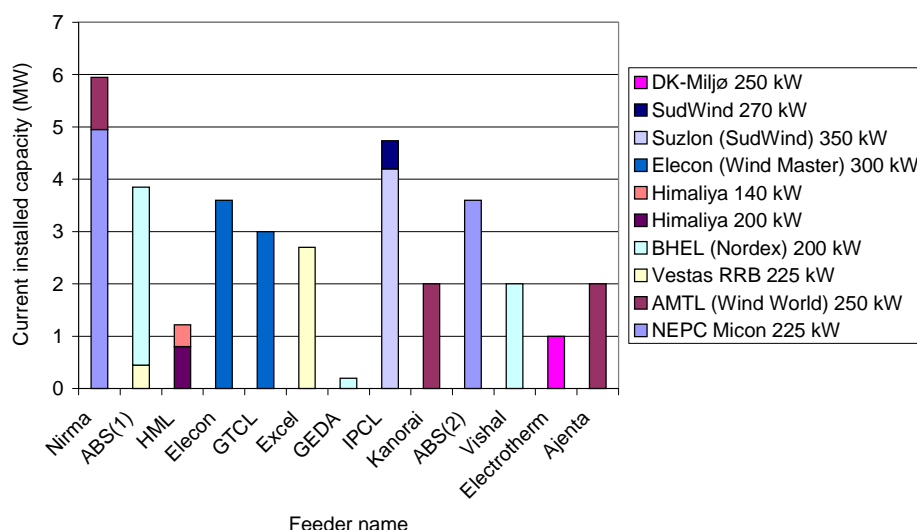

Figure 4. Feederwise wind turbine installations in the Dhank substation.

All the wind turbines in Dhank use induction generators, directly connected to the grid. These machines have installed capacitor banks to compensate for the no load consumption of reactive power in the induction generators.

Figure 5 shows the measured instantaneous values of reactive power, both on the 66 kV bus bar and in the 11 kV connection points of each feeder to the substation.

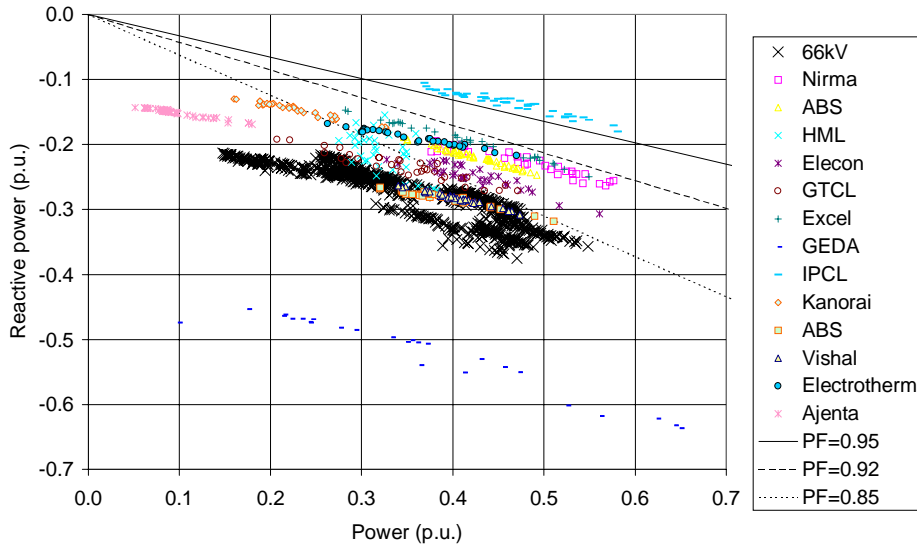

Figure 5. Feederwise reactive power consumption in the Dhank substation.

Only in the IPCL feeder, the wind turbines seem to be properly compensated. In the other end, the GEDA feeder has the highest reactive power consumption. All the other feeders have too poor reactive power compensation, and a rough estimate suggests that half of the capacitor banks in the wind turbines are not working.

The corresponding feederwise results for the Lamba substation are shown in Figure 6 and Figure 7. These results are similar to the Dhank results, indicating faulty reactive power compensation. Only, the Lamba results are based on a reduced operating capacity due to the cyclone damage.

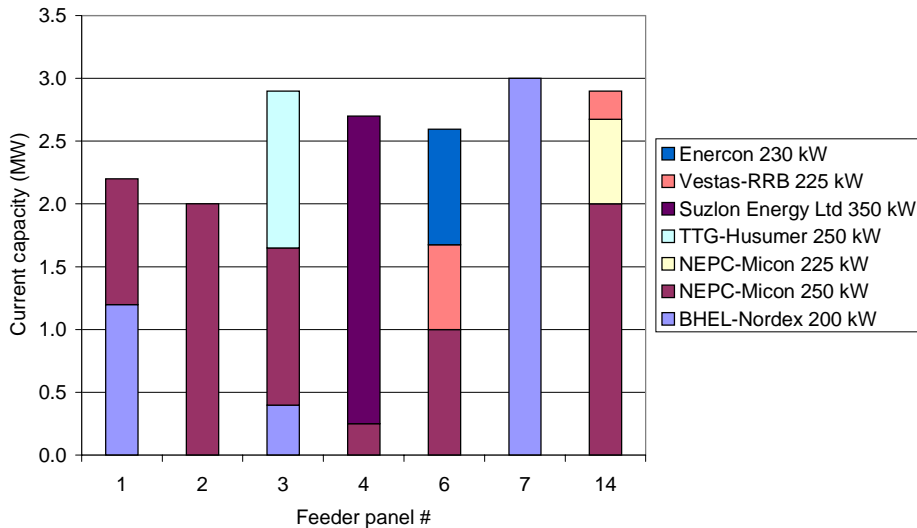

Figure 6. Feederwise wind turbine installations in the Lamba substation.

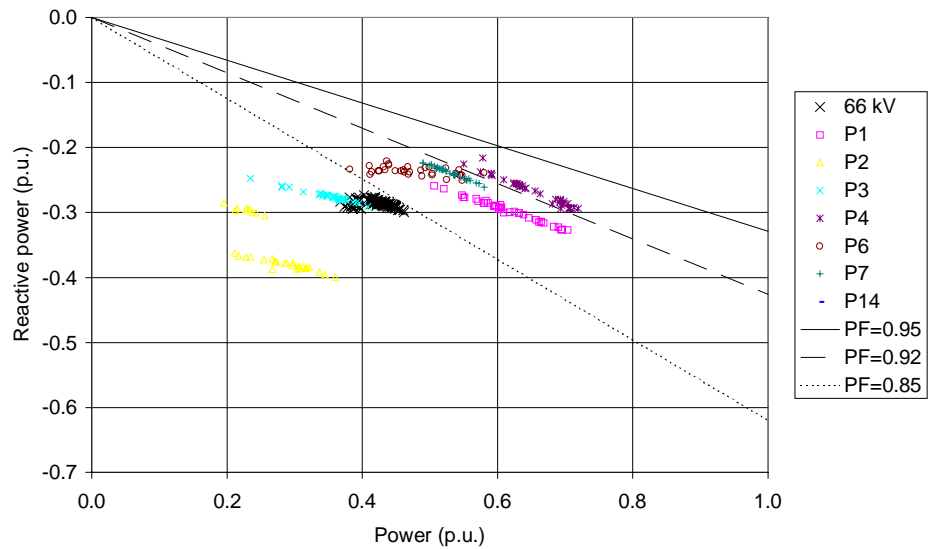

Figure 7. Feederwise reactive power consumption in the Lamba substation

The reactive power compensation measured in 7 individual wind turbines is shown in Figure 8. Two of the wind turbines are with IGBT based power converters, and none of these wind turbines consume reactive power on the wind turbine terminals. The remaining five wind turbines use directly connected induction generators. Three of the five wind turbines with directly connected induction generators have defect capacitor banks.

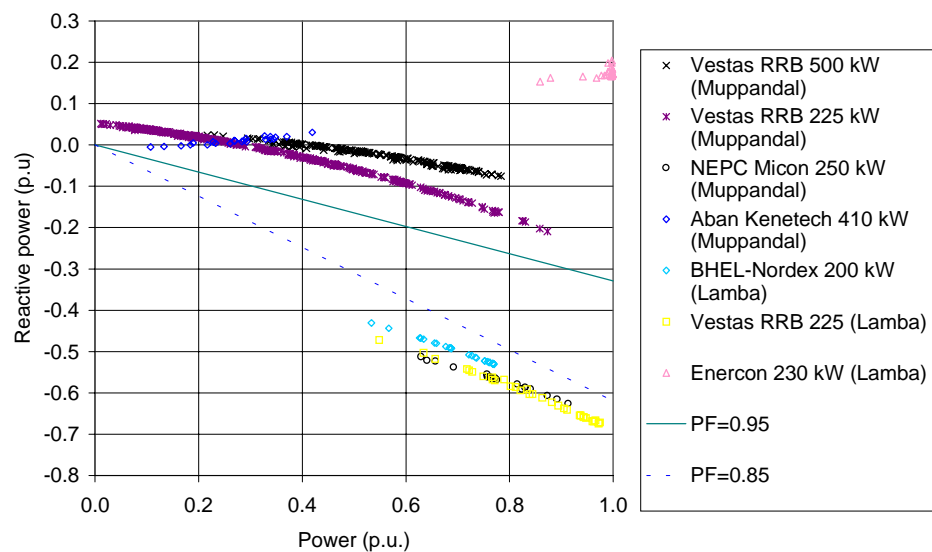

Figure 8. Reactive power consumption in individual wind turbines.

The measurements in the wind turbines confirm that the reactive power is better compensated in Tamil Nadu (1/3 defect capacitor banks) than in Gujarat (2/2 defect capacitor banks). But the statistical significance is very poor, based on measurement in three wind turbines in Tamil Nadu and two wind turbines in Gujarat.

The wind turbine owners were aware that the reactive power consumption should be compensated by capacitors, and also aware whether the capacitor

banks were working or not. However, in Gujarat the owners have no incentives, only additional expense, if they choose to replace the faulty capacitors.

The graph in Figure 8 also shows a very flat PQ curve for the Vestas 500 kW wind turbine. This is because Vestas uses generators with a very low leakage inductance in the 500 kW wind turbines. With such generator, the power factor will be good, even at rated power production.

3.4.2 Voltage and current unbalance

The unbalance of voltage or current in a power system is defined as the ratio between the negative phase sequence component (or simply the “reverse”) and the positive phase sequence component.

MNES has issued Wind Farm Planning Considerations in [3]. These considerations specify that the grid should not exceed 15 % unbalance. It is, however, not explicit specified if the 15 % are voltage or current unbalance. On the one hand, it would be most appropriate to specify limits for voltage unbalance, because the voltage unbalance specify the grid, whereas the current unbalance specifies the combination of the grid and a particular induction generator. On the other hand, 15 % voltage unbalance is a meaningless, wide specification. Therefore, the 15 % are assumed to specify limits for current unbalance in the wind turbines.

IREDA's Technical Specifications require that the wind turbines are capable of operating with 12.5 % unbalance, which is also assumed to mean current unbalance.

The European voltage quality standard EN 50160 [6] requires 2 % as limit for the 95 % percentile of the voltage unbalance on the medium voltage level.

The voltage unbalances measured on the primary sides of the 5 selected substations are shown in Figure 9. It is seen that the measured ten minutes average voltage unbalance is less than 2 % during the entire measurement period, and the voltage unbalance is not correlated with the wind farm output power.

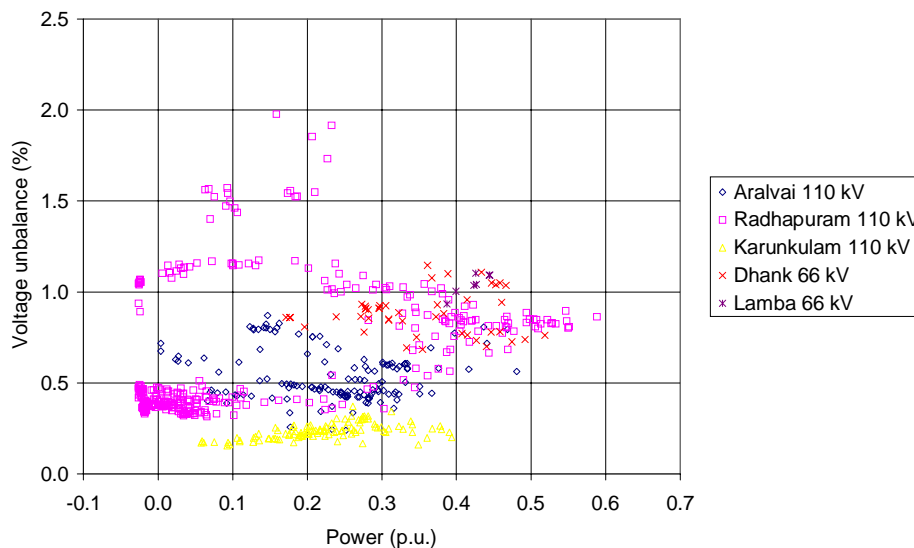

Figure 9. Voltage unbalance on primary sides of substations.

The corresponding current unbalances on the primary sides of the substations are shown in Figure 10.

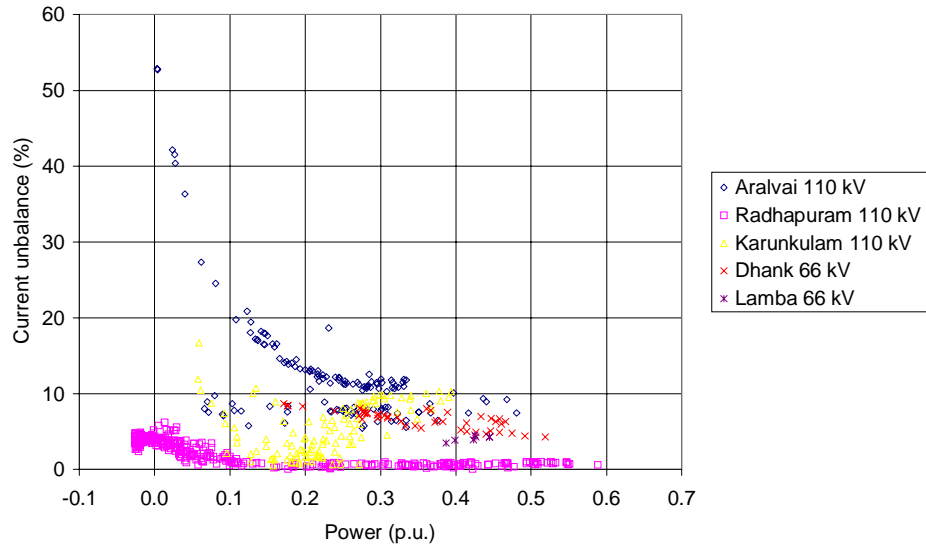

Figure 10. Current unbalance on primary sides of substations.

The markers in Figure 10 show that the current unbalance increases for low power production in the three substations in Tamil Nadu. The increased current unbalance is a consequence of the decreased currents rather than increased reverse currents. This is shown in Figure 11, where the reverse currents are given in p.u. of rated current.

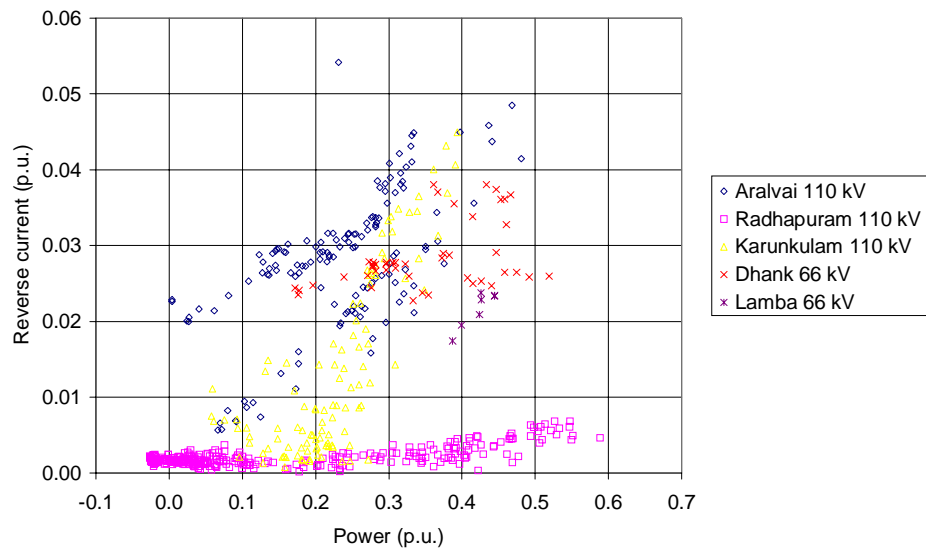

Figure 11. Reverse currents on primary sides of substations.

The markers indicate that the reverse current generally increases with the power. This increment in reverse power is most likely originating from the wind turbines, because they are the only generation on the substation. Another source to the reverse current is unbalanced loads on the rural feeders, which are connected to the selected Tamil Nadu substations.

The reverse current in Radhapuram does not increase as much with power as the reverse current in the other substations. Also, the current unbalance is very low in Radhapuram, despite the relatively high voltage unbalance. This is probably because the phase currents are controlled actively in the IGBT based power converters in the wind turbines.

Contrary to the wind turbines with power converters, the phase currents in the directly connected induction generators respond passively to the unbalanced voltage. The reverse sequence of the voltages causes a reverse field in the rotor with approximately fundamental frequency, which again causes significant losses and heating of the generator.

Also the thyristor based power converters in Karunkulam are effected by the voltage unbalance.

The Dhank substation has the highest reverse currents, corresponding to the highest voltage unbalance except from Radhapuram.

To stabilise the grid conditions, MNES recommends to evacuate power through 33 kV or above in the Wind Farm Planning Considerations issued in [4]. This evacuation policy will limit problems with voltage unbalance. The present measurements have all been taken on dedicated wind turbine feeders and (almost) dedicated substations, which explains the measured low values of voltage unbalance.

3.4.3 Voltage ranges and grid availability

The Indian voltage quality standard IS 12360-1988 [7] specifies a tolerance of $\pm 12.5\%$ on 66 kV level and above. Figure 12 shows 10 minutes averages of the measured voltages on the 110 kV level of the substations in Tamil Nadu in May 1999 and 66 kV level of the substations in Gujarat in June 1999.

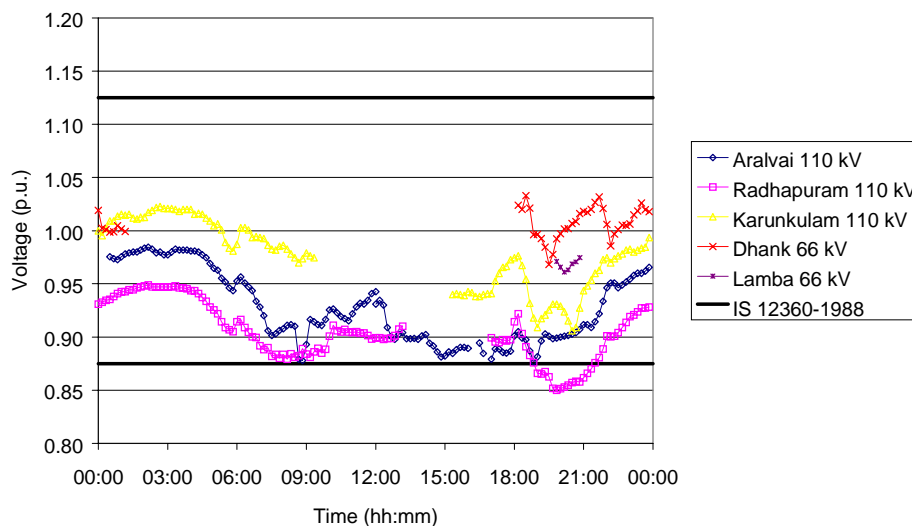

Figure 12. Steady state voltages on substations in Tamil Nadu.

In addition to the measurements on different substations in Figure 12, a series of measurements on the 110 kV level in the Radhapuram substation have been acquired in August and October 1999. These measurements are shown in Figure 13.

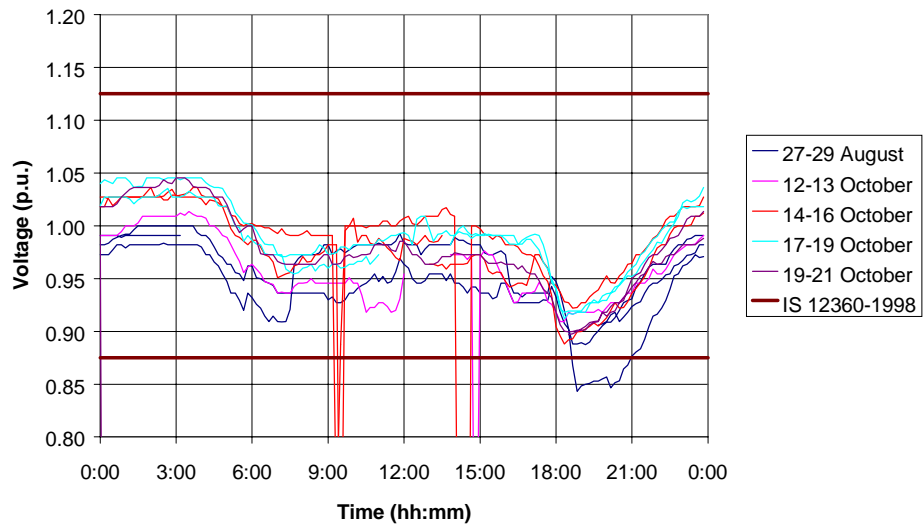

Figure 13. Stationary voltages Radhapuram substations in Tamil Nadu.

The curves in Figure 12 and Figure 13 show similar diurnal variations, with voltage decrements during peak load period in the evening and voltage increments at night. The steady state voltage in Radhapuram was below the 12.5 % limit in two days during the measurement period.

The transformers in the substation in Karunkulam have automatic tap changers. This is also assumed to be the case in the other substations in Tamil Nadu. In that case, the low voltages on the 110 kV level will not influence the stationary voltages on the wind turbine feeders.

In Gujarat, the transformers in Dhank have automatic tap changers to control the voltage on the secondary side, whereas the Lamba substation has no voltage regulation. This may cause large voltage variations on the wind turbine feeders in Lamba, but we have not enough measurements on the Lamba feeders to verify this.

MNES's Wind Farm Planning Considerations specify that the voltage increase at each wind turbine should be less than 13 % of the rated voltage. The measured instantaneous values of the voltages on the wind turbine terminals are shown in Figure 14. The measurements show that the voltage increment at the wind turbines is below the specified 13 % of rated voltage.

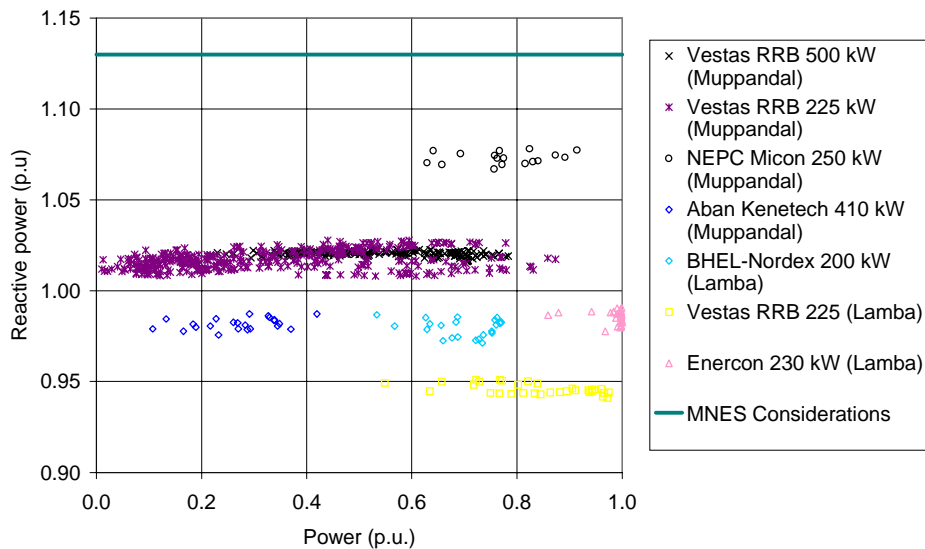

Figure 14. Instantaneous voltages in wind turbines.

The measurements in Figure 12 were taken without the UPS connected to the power supply of the Voltech. As a consequence, these measurements did not reveal any outages. Figure 13 shows measurements, where the Voltech is supplied through a UPS. The curves reveal four outages during 12 days of measurements, all with a duration less than one hour.

The number and duration of outages at the wind turbine terminals may be more severe, because errors in the power collection system of the wind farm are not registered by the measurements on the 110 kV bus bar.

3.4.4 Frequency range

According to IS 12360-1988, the frequency should be 50 Hz \pm 3%. The measured 10 minutes average values of the frequency in Muppandal in May 1999 and Gujarat June 1999 are shown in Figure 15. The measurements show that the specified 48.5 Hz limit in IS 12360-1988 is exceeded almost every day.

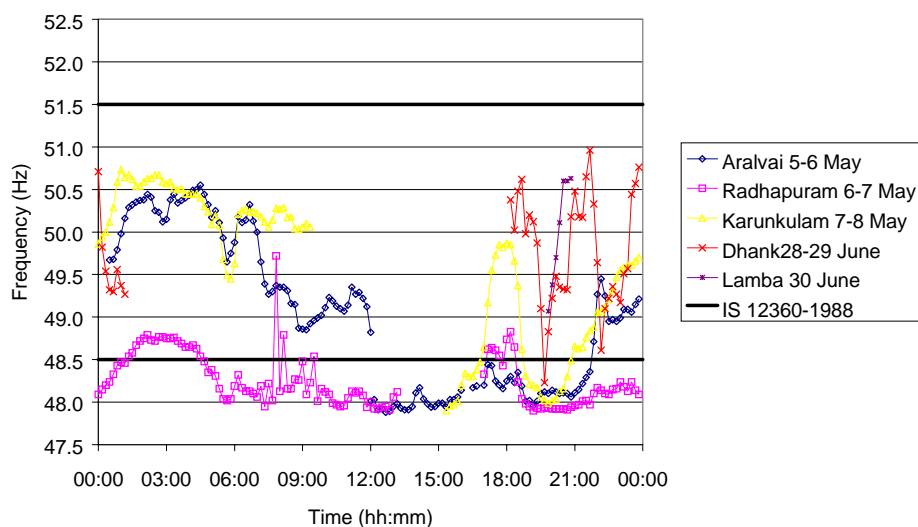

Figure 15. Frequencies measured on different days in substations in Tamil Nadu May 1999 and Gujarat June 1999.

The frequency has also been measured in Radhapuram substation in August and October, while also the voltages in Figure 13 were measured. The results are shown in Figure 16.

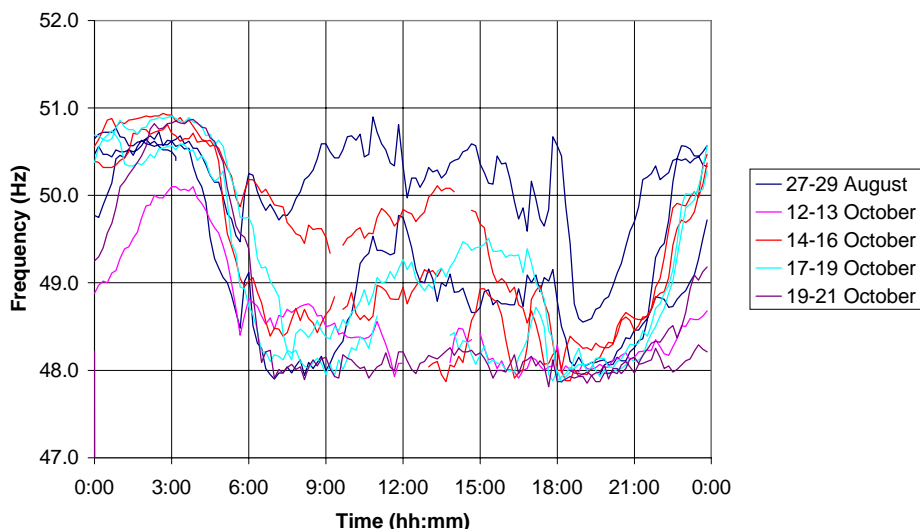

Figure 16. Frequencies measured in Radhapuram substations in Tamil Nadu.

The diurnal variation in frequency in Figure 15 and Figure 16 is similar to the variation in the voltages in Figure 12 and Figure 13. The frequency increases during the night, falls during the day, and has a distinct drop during the peak load period from 18:00 to 21:00. However, one of the curves is not decreasing during the day, and the frequency in the period from 9:00 to 15:00 is above 50 Hz. That curve represents measurements acquired on a Sunday.

These measurements strongly indicate that the frequency is floating until it reaches a lower limit of 48 Hz. Then the electricity boards are regulating the frequency, preventing it to drop below 48 Hz.

3.4.5 Harmonics and interharmonic distortion

The European standard EN 50160 specifies 8 % as limit for the total harmonic voltage distortion $THD_{U\%}$ defined as

$$THD_{U\%} = \frac{\sqrt{\sum_{h=2}^{40} U_h^2}}{U_1} \cdot 100\% \quad (1)$$

where U_h is the amplitude of the h'th harmonic.

This definition does not include interharmonics, i.e. distortion at frequencies which are not integer multiples of the fundamental. To include all distortion, we use the total voltage distortion factor $TDF_{U\%}$ defined as

$$TDF_{U\%} = \frac{\sqrt{U_{RMS}^2 - U_1^2}}{U_1} \cdot 100\% \quad (2)$$

Figure 17 shows the voltage distortion factors measured on the primary sides of the substations. The voltage distortion in Figure 17 is normalised with the rated voltage U_n instead of U_1 as in (2).

All the measurements confirm that the total harmonic distortion is less than 8 %, because the total harmonic distortion will always be less or equal to the distortion factor, i.e. $THD_{U\%} \leq TDF_{U\%}$.

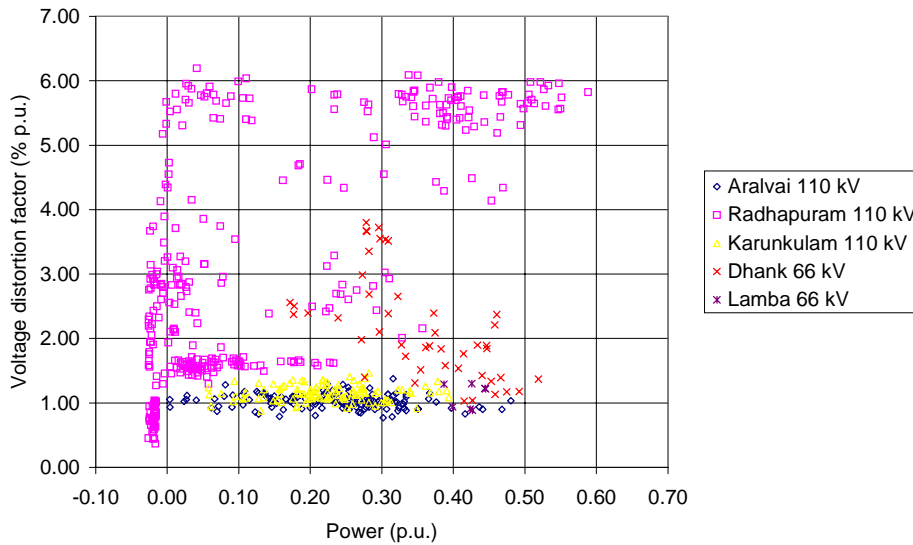

Figure 17. Voltage distortion factors measured on primary sides in substations

The most significant distortion encountered from Figure 17 is from the Radhapuram substation. The reason for the distortion could be the frequency converters in the wind farm. However, the distortion factor has a pronounced diurnal variation as seen in Figure 18, which could indicate other sources than the frequency converters.

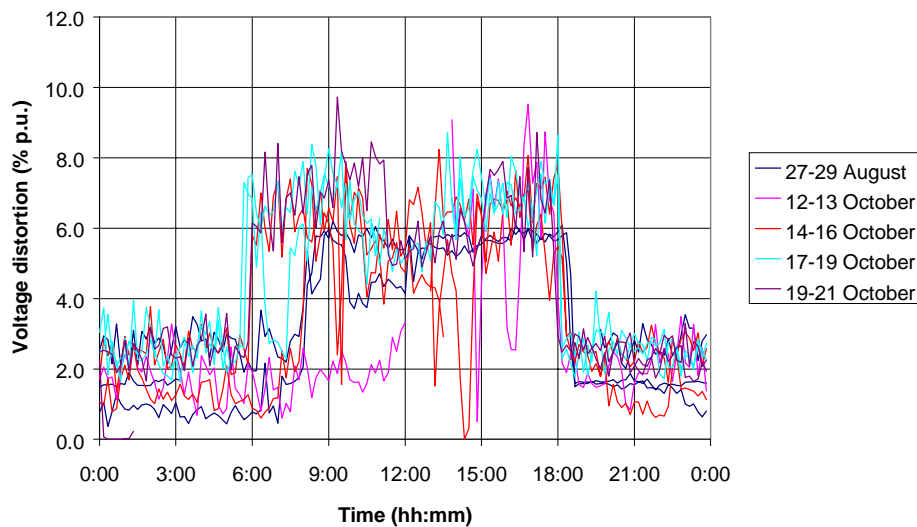

Figure 18. Voltage distortion factors measured on primary side in Radhapuram substation.

To study the possible sources to the distortion in Radhapuram, the waveforms have also been logged in October, recording 30 milliseconds every 1 minute with 25 kHz sampling frequency. The logged waveforms have then been Fourier transformed to give the harmonics.

Figure 19 shows a square average of the harmonics in 16 periods. The measurements have been taken in a period with high distortion, according to Figure 18.

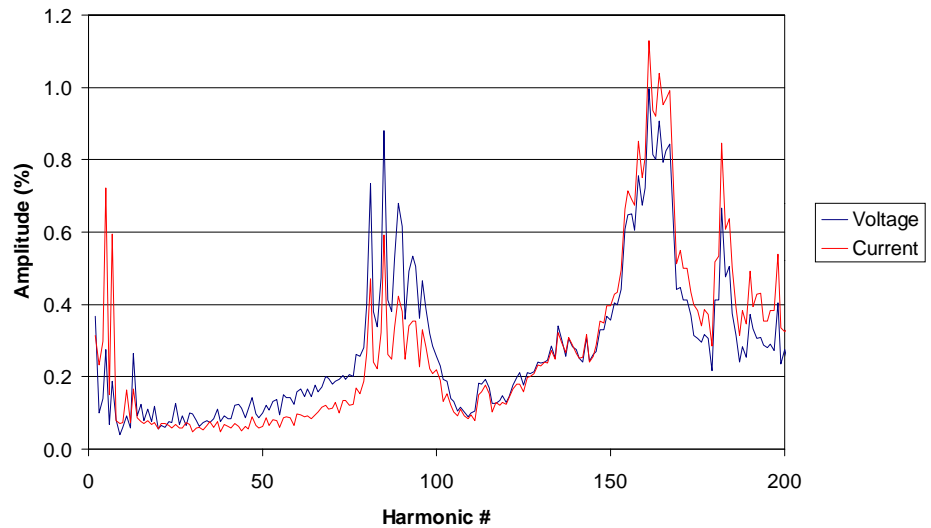

Figure 19. Harmonic amplitudes of voltage and current measured in Radhapuram substation.

According to the operator, most of the power converters in the Aban Kennetech wind turbines use 5 kHz switching frequency. Other power converters should use 20 kHz, which sounds unrealistic due to high switching losses. The two groups of harmonics around the 85th and 160th in Figure 19 are likely to originate from a power converter with a switching frequency around 4.3 kHz.

The measurement of these high frequency distortions is very imprecise, because the CTs, PTs and current clamps are not dedicated to the high frequencies. Therefore, the size of the distortion is very uncertain. Still the measurements have been included in the report, as they indicate a high level of distortion, both of voltages and of currents.

The waveforms have also been measured with 25 kHz samples in two of the wind turbines connected to Radhapuram substation. The first wind turbine was one with 5 kHz switching frequency. The harmonics in this wind turbine are shown in Figure 20. The peaks correspond very well with the peaks in Figure 19.

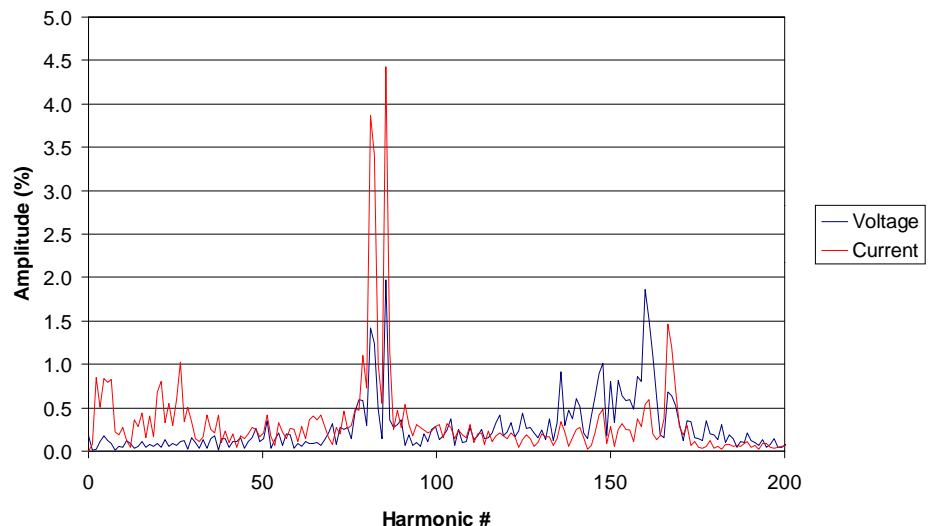

Figure 20. Harmonic amplitudes of voltage and current measured in the Aban Kennetech wind turbine with 5 kHz switching frequency.

Figure 21 shows the harmonics measured in the other wind turbine. This power converter generates distortion in a much larger bandwidth. According to the operator, the switching frequency of the converter in this wind turbine is 20 kHz. It is not a familiar harmonic distribution like the distortion in Figure 20.

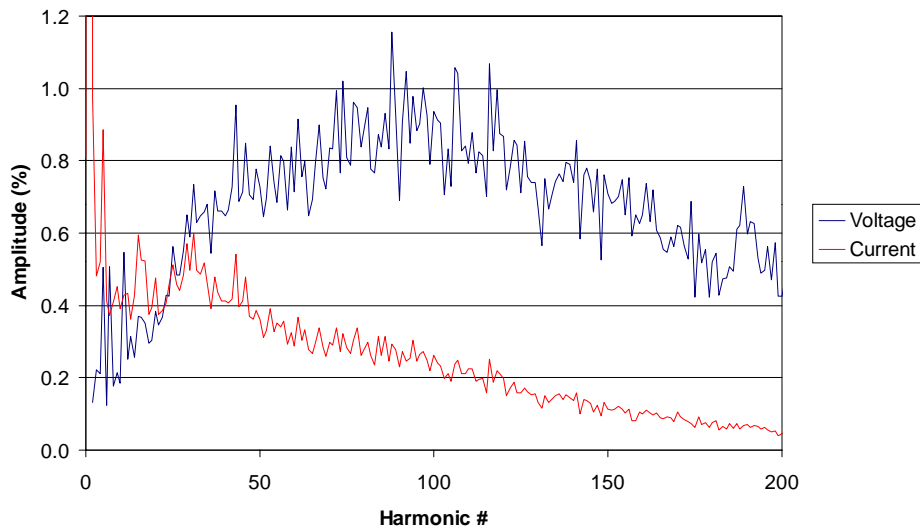

Figure 21. Harmonic amplitudes of voltage and current measured in Radhapuram substation.

The conclusion on the distortion in Radhapuram is that the source must be the power converters in the wind farm, based on the comparison of Figure 19 and Figure 20. The reason for the diurnal variation in Figure 18 is most likely, that the impedance in the grid changes, e.g. due to connection and disconnection of capacitors. However, the size of the distortion in the substation is very uncertain, because the measurement setup is not dedicated for measurements up to 10 kHz. The power analyser itself can manage, but the CTs and PTs in the substation are not designed to such frequencies, and the mini current clamps used in the substation have cut-off frequency 1 kHz as mentioned in clause 3.3.1.

The distortion shown in Figure 17 on the Dhank substation has been identified as dominated by a 5th harmonic. Figure 22 shows the current distortions measured in the Dhank substation. The current distortions have been normalised to the rated current.

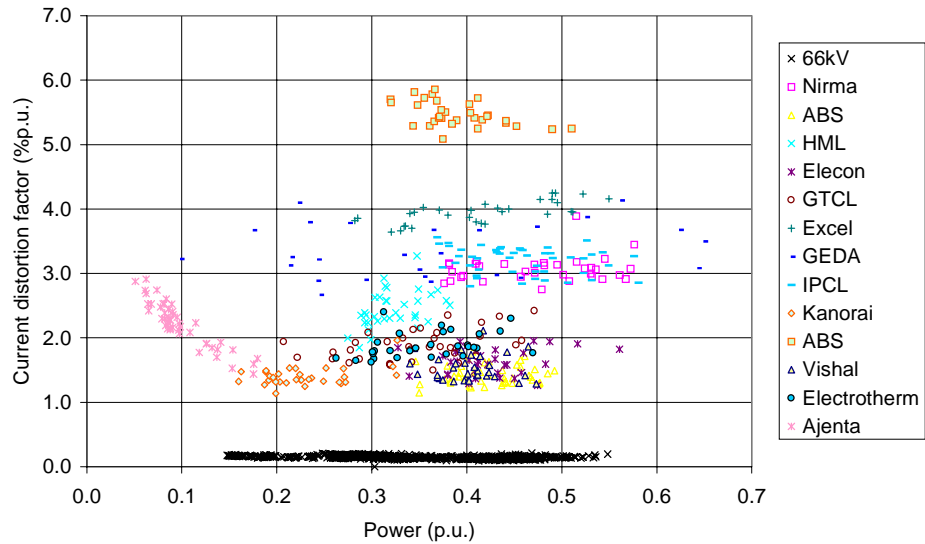

Figure 22. Current distortion factors measured in Lamba substation.

Similar normalisation is also the practice in the draft IEC 61400-21 standard for Measurement and Assessment of Power Quality Characteristics for Grid Connected Wind Turbines [8].

Figure 22 indicates that the distortions are fairly independent of the power. The dominating distortions have been identified as 5th and 7th harmonics, most likely due to the windings in the induction generators.

Measurements of voltage distortion factors on wind turbine terminals in the wind farms are shown in Figure 23.

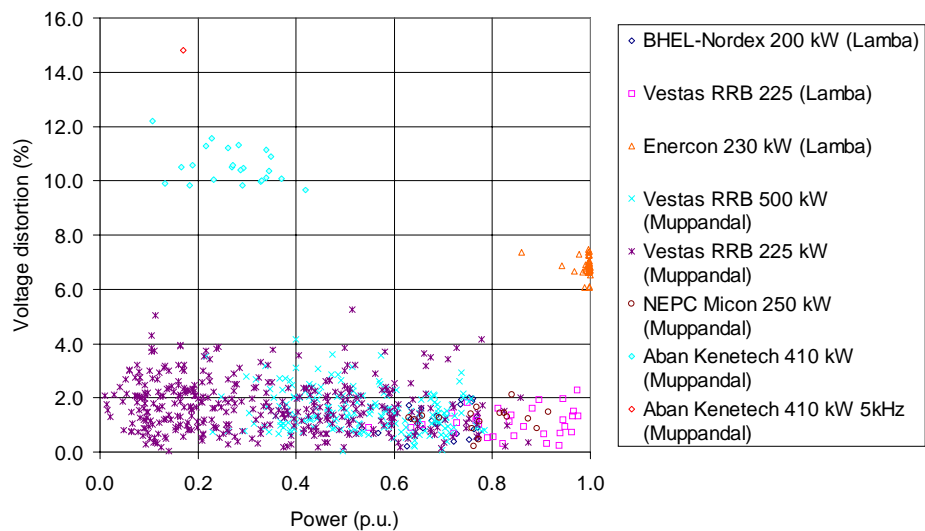

Figure 23. Voltage distortion factors measured on wind turbine terminals.

The voltage distortion is 10-15 % on the terminals of the Aban/Kennetech wind turbine and 6-8% on the Enercon. On the other wind turbines, the voltage distortion factor is only 0-4%. The voltage distortions at the terminals of the Aban/Kennetech and Enercon wind turbines, with power converters, are at higher frequencies, and these can easily be filtered if required. In the case of the other wind turbines, with directly connected induction generators, the distortion is at lower frequencies, and filtering is much more expensive.

The Vestas machine in Lamba is connected to the same feeder as the Enercon machine. The waveforms of voltage and current have been measured in the

Vestas machine, and they show some distortion around the switching frequency of the Enercon wind turbine (1 kHz). But the measured voltage distortion in the Vestas machine is below 2.5%, which is harmless. In that context, it should be noted that the capacitors in that Vestas machine were defect. A working capacitor bank would have changed the impedances on the feeder for the high frequencies.

3.4.6 Voltage fluctuations

Voltage fluctuations caused by wind turbines are assumed to be of minor importance in India. Therefore, voltage fluctuations and flicker have not been measured.

Most of the wind turbines are installed in large wind farms connected to dedicated feeders at a higher voltage level. The stochastic nature of the power fluctuations from wind turbines will smooth the relative fluctuations from a wind farm compared to a single wind turbine. Especially the fast fluctuations which cause flicker emission will be reduced.

3.5 Summary

The results presented in this chapter are summarised as follows:

- The reactive power consumption of the wind farms is significantly higher in Gujarat than in Tamil Nadu. The reason for the high reactive power consumption in Gujarat is that approximately half of the capacitor banks in the wind turbines in Gujarat are defect. In most cases, the owners were aware that the capacitor banks were defect, but in Gujarat, there are no incentives to replace the capacitor banks.
- 4-5 outages have been measured during 12 days of continuous logging on the 110 kV level in the wind farm substation Radhapuram in Tamil Nadu. The number of outages on the wind turbine terminals will always be higher than the number of outages on the high voltage level of the substations, because faults in substation and the power collection system in the wind farm will add to the faults, which can be measured on the 110 kV level. The voltages were only logged during few hours in wind turbines, so these additional faults have not been quantified.
- The measured voltage range on the 110 kV level in Muppandal is from +5% to -15 %, which exceeds the 12.5 % lower limit in IS 12360-1988 during peak load periods.
- The voltage unbalance has been measured to less than 2 % in all the selected substations. Voltage unbalance has been identified as a problem in rural load feeders with wind turbines, but the measurements have only been performed in wind farms with dedicated feeders.
- The measured frequency range is from 51 Hz to 48 Hz. Consequently, the lower limit is 4 % below the rated 50 Hz, which exceeds the ± 3 % frequency limit in IS 12360-1988.
- A significant voltage distortion has been measured on the 110 kV level on the substation in Radhapuram. The frequency converters in the wind farm are most likely the source.

4 Power factor improvement schemes

4.1 General

The poor power factors due to inductive agricultural loads and induction generators in wind turbines have been identified as a critical issue in clause 2.3. This section provides an overview of possible ways to improve the power factors. Some of the improvements are already implemented, but they are included for the sake of completeness. The overview was presented in a paper by K.A.Fathima et. al. [9] at the workshop in India.

Reactive power has a dominating influence on the voltage. Theoretically, the voltage drop across a transmission line depends mainly on the reactance of the line and the reactive power flow, assuming the line resistance as very low. If the reactive power requirement is supplied locally by connecting a var compensator, the voltage drop across the line is reduced and flicker can be improved.

Reactive power compensation can be achieved in different ways. The simplest method is to connect a capacitor in parallel with the load. Devices like synchronous condensers and saturable reactor compensators are also popular. However with rapidly varying voltage fluctuations due to the nature of wind, it is difficult to improve the power quality with the aid of these simple compensators. Advanced reactive power compensators with fast control and power electronics have emerged to supersede the conventional compensators.

4.2 Capacitor compensation

Due to the low cost, shunt capacitors are the most commonly used scheme to compensate for reactive power compensation in wind turbines with induction generators. Shunt capacitors are also widely used on higher voltage levels, e.g. in substations.

In wind turbines with directly connected induction generators, shunt capacitors are connected in banks and switched in and out of the circuit using contactors. Due to the surge current taken by the capacitors while switching in, the lifetime of the contactors is limited. Another disadvantage is that the reactive power capability of the capacitors falls drastically at lower voltages, leading to reduced effectiveness.

Another similar scheme known as Thyristor Switched Capacitors is also used widely. In this scheme, capacitor banks are connected in series with a bi-directional thyristor pair, and a small inductor. The inductor is provided to limit switching transients and inrush currents.

In three-phase configuration, the capacitors are connected in delta. Reactive power control is achieved by switching in and out individual capacitor banks. Thus the control is achieved in steps. The switching of capacitors excites transients, and so the switching has to be done by keeping these transients minimum. The switch off occurs at current zero after an integral number of half cycles. Since the reactive power varies continuously, the limited variability of only a few capacitance values is a notable disadvantage. In this scheme, the output characteristics is discontinuous and determined by the rating and number of parallel connected units. Therefore the voltage support provided will be discontinuous.

4.3 Synchronous Condenser

A synchronous condenser is a synchronous motor without mechanical load. When overexcited, it operates as a condenser. Synchronous condensers have advantage of flexibility of operation under all load conditions. However it's slow response and the requirement of starting and protection facilities, and frequent maintenance do not meet with much popularity.

4.4 Thyristor Controlled Reactors

The presently available Static VAR compensators mainly use thyristor controlled reactors (TCR). This system basically consists of an inductance in series with a bi-directional thyristor pair. The current flow in the inductor is controlled by adjusting the firing angle of the thyristors. Control over the inductor value is possible with firing angles between 90° and 180° . The TCR compensator is bi-ased by shunt capacitors so that it's overall power factor can be either lagging or leading.

Under the phase control mode, TCR generates higher harmonic currents. In three phase systems, the third harmonic is cancelled by connecting the TCR elements in delta. Further elimination of harmonics is possible by using additional filter elements.

4.5 Inverters with force commutated switches

A wide variety of advanced power switching devices have emerged recently, with fast switching and power carrying capability. As a result, the performance levels of power electronics converters have improved to a larger extent at competitive costs. The new generation of switches are already widely used in motor drives, wind turbine applications and as power quality improvement.

The new, fast switches are force commutated, which makes it possible to make power converters with controllable reactive power, and also to eliminate the low harmonics. The low harmonic emission from thyristor based power converters require large filters. Moreover, the prices of the fast switches are steadily falling.

The most common use of force commutated switches in wind turbine applications is power converters, utilising the ability to control the rotor speed of the wind turbine by controlling the frequency of the generator voltage. Another application is an advanced static var compensator (ASVC). In Denmark, a 8 Mvar ASVC has been installed to compensate for the reactive power consumption on the 24 MW wind farm in Rejsby Hede, described in [10] and [11].

5 Induction generators interaction with weak grid

This section gives a short introduction to the behaviour of an induction generator, when it is connected to a weak grid. The influence of voltage and frequency deviations are studied, together with the influence of unbalanced voltages.

The phase equivalent of the induction generator is used in the calculations presented. All calculations are based on the data of a 225 kW generator. The equivalent is shown in Figure 24.

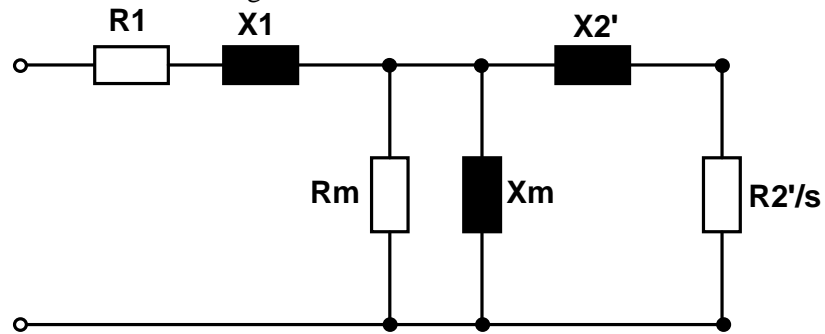

Figure 24. The induction generator equivalent.

- R1: Stator resistance
- X1: Stator leakage reactance
- R2': Rotor resistance (converted to the stator side)
- X2': Rotor leakage reactance (converted to the stator side)
- Xm: Magnetising reactance (main reactance)
- Rm: Iron losses.
- s: Slip

5.1 Voltage variations

Figure 25 illustrates how the torque curve of the induction generator is affected if a voltage occurs which is lower than the design criteria. It is seen that the maximum torque is reduced, when the voltage is reduced.

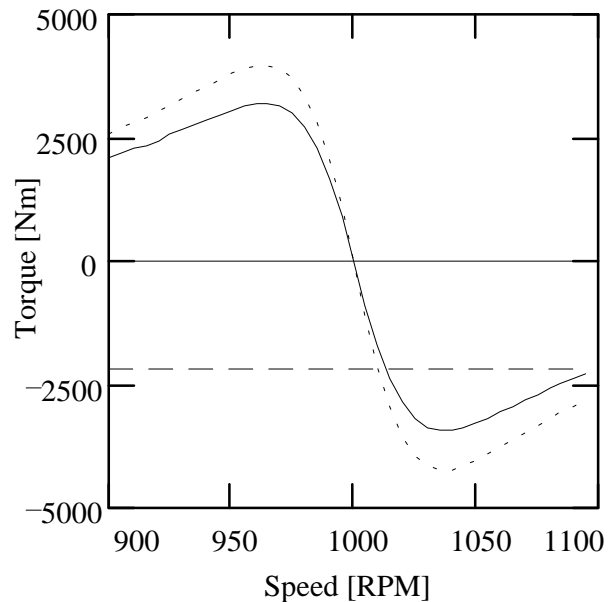

Figure 25. The generator torque versus the generator speed. Two cases are shown, $U = 400$ V (dotted line) and $U = 360$ V (solid line). The frequency is kept constant. The dotted line with a constant torque is the nominal torque on the main shaft of the wind turbine at a constant wind speed.

Even though the voltage on the generator terminals decreases, the same amount of mechanical energy still has to be converted into electrical energy by

the generator, provided that the wind speed is unchanged. It is assumed that the change in the efficiency of the rotor blades due to a minor change in rotor speed is negligible. This means that the rotor speed of the generator will increase until it reaches a new steady state point on the torque curve. In Figure 25, a line with a constant value (approx. -2200 Nm) illustrates the torque on the generator shaft.

A 10 % lower voltage would, in this particular example, speed up the generator as the slip changes from -1 % to -1.3 %, which correspond to approx. 3 RPM on the generator shaft. This relatively small change in the slip/speed is explained by a steep torque curve, which generally characterises generators used for wind turbines.

Because of an almost unchanged active production, a decreasing voltage will lead to an increasing rotor and stator current. Larger currents enhance the consumption of reactive power in the leakage reactances, although this is, to some extent, counterbalanced by a smaller magnetising current, due to the lower voltage level.

Figure 26 shows the consumption of reactive power for a typical induction generator versus the voltage level in p.u. The active power production is kept constant at five different fractions of the rated production P_n .

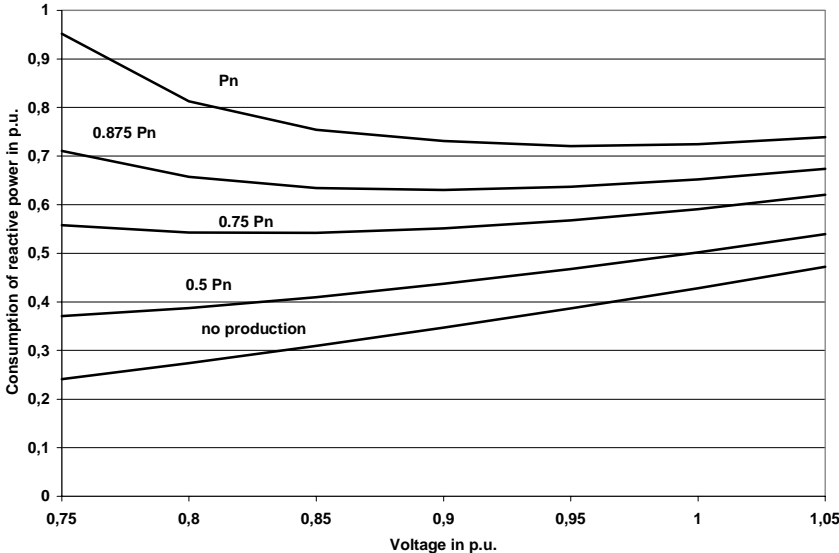

Figure 26. The consumption of reactive power at different power levels versus the voltage in p.u. The frequency is 50 Hz.

5.2 Frequency variations

If a generator is operating at a lower frequency than the design frequency, the result is a change of the rotor speed and a slightly increased consumption of reactive power.

At 50 Hz the synchronous speed of a 6-poled machine is 1000 RPM. At 48 Hz the synchronous speed drops to 960 RPM. A lower synchronous speed will change the rotor speed and consequently may change the aerodynamic efficiency of the wind turbine. This effect is not included in the present calculations, because only the relation between the active and the reactive power of a specific generator is calculated.

Figure 27 shows the changes in reactive power consumption vs. frequency for the induction generator operating at rated power and rated voltage. It is seen that

the reactive power consumption is increased at frequencies lower than 50 Hz, but the increment is very small.

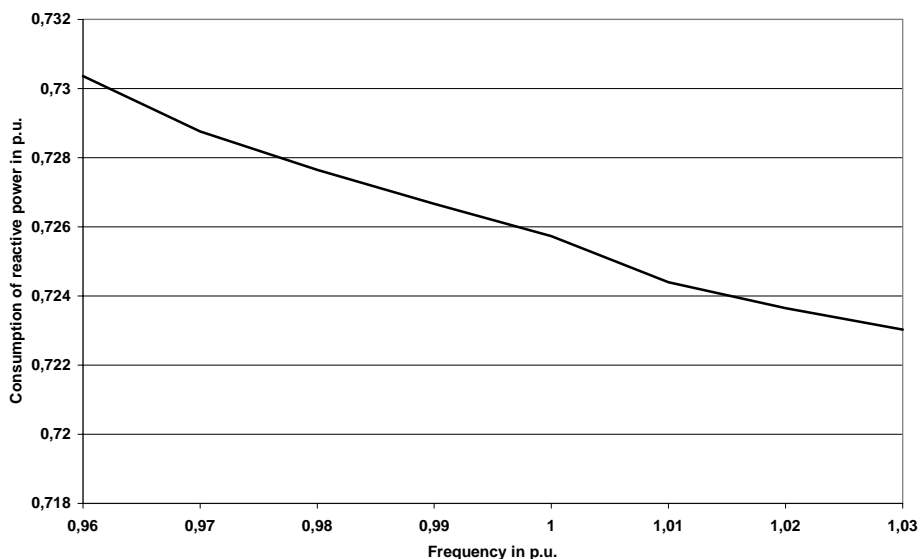

Figure 27. The reactive power consumption in a generator versus the frequency. The voltage at the generator terminals is kept constant.

The increased reactive power consumption is caused by the reduced magnetising reactance ($X = 2\pi \cdot f \cdot L$, f : frequency, L : inductance). Even though, the lower frequency will reduce all the reactances of the generator, the shunted magnetising reactance X_m (see Figure 24) is dominating in size compared to the leakage reactances X_1 and X_2' , which causes an increased consumption (provided that the voltage is unchanged).

The increased consumption of reactive power is relatively higher if the production is less than 100 % P_n , e.g. 50 % of P_n , due to a smaller current through the leakage reactances. This is illustrated in Table 1, where the consumption of reactive power in different production points is shown for the 50 Hz and the 48 Hz case.

Table 1. Consumption of reactive power in different production points, shown for the 50 Hz and 48 Hz case

Active production	Consumption of reactive power at 50 Hz [kvar]	Consumption of reactive power at 48 Hz [kvar]
0.3 % of P_n	96 (42.7 %)	100 (44.4 %)
50 % of P_n	114 (50.7 %)	117 (52.0 %)
P_n	163 (72.6 %)	164 (73.0 %)

5.3 Voltage unbalance

Voltage unbalance in the grid where a wind turbine is installed may have significant impact on the performance of the generator.

The presence of unbalance in the voltage will create a negative sequence voltage in the generator. The existence of this affects the air-gap flux of the induction generator and with that the current in the rotor. Under symmetrical conditions this current will have a frequency equal to $s \cdot f$ (s : the slip, f : the frequency

of the stator field), but when a negative sequence component appears in the voltage, the sinusoidal flux and the rotor current will be distorted. The negative sequence current in the rotor has a frequency equal to approximately $(2-s)\cdot f$.

The distortion of the flux and the rotor current depends on the degree of unbalance, i.e. the level of the negative sequence voltage. A large unbalance in the voltage will increase the losses in the generator, and at worst cause unintended fluctuations in the mechanical parts of the system.

Another obvious result of unbalanced voltage in the grid is a corresponding unbalanced current delivered to the grid. While the power production is unchanged (or slightly decreased) an unbalanced current means, that some of the phases carries larger currents compared to the balanced situation. A larger current in a single phase increases the losses, and at worst the generator might be overloaded.

A simple example has showed that a 3 % unbalance in the voltage will cause a 6-7 % *decrease* of the current in one phase and an *increase* of the phase-current in the other two phases with 10-20 %.

The influence of voltage/current unbalance on the power factor is discussed in Section 6.3.6.

6 Capacitor compensation in wind turbines

6.1 General

The implications of compensation for reactive power with power shunt capacitors have been investigated, and the main results have been presented in a paper by A.Vikkelsø et. al. [12] at the Workshop in India. This section gives a more detailed description of the results.

6.2 No-load compensation

The reactive power compensation for wind turbines with directly connected induction generators is traditionally done with capacitor banks, which is an economic and relatively simple solution. In order to avoid problems with overvoltages, especially in island situations, no-load compensation is most commonly used. No-load compensation means, that the compensation is designed to counterbalance the consumption of reactive power in the no-load situation, where the generator torque is zero.

Figure 28 illustrates a typical example of a capacitor bank compensated wind turbine. In the figure, two banks of capacitors are compensating for the no-load consumption of the induction generator. These capacitors are controlled by the wind turbine. The third capacitor is installed on the grid side of the main switch, and it is designed to compensate for the reactive power consumption in the step-up transformer.

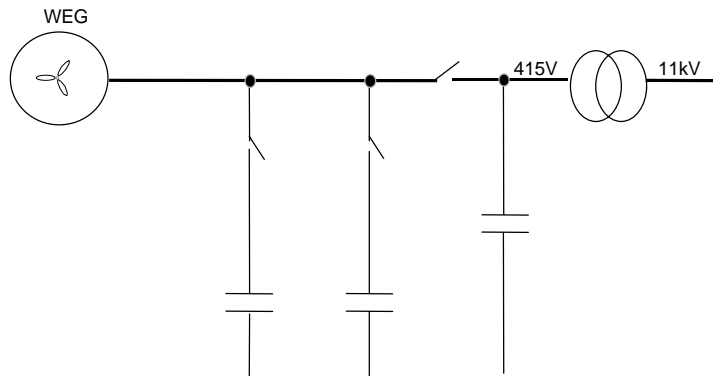

Figure 28. A typical example of reactive power compensation by the use of capacitor banks.

6.3 Influences on power factor

6.3.1 Generator

A high power factor for wind turbines ($\cos \phi > 0.95$) can be obtained by the use of capacitor banks, in an electricity system with an ideal power quality. The improvement of the power factor in the case of no-load compensation is shown in Figure 29.

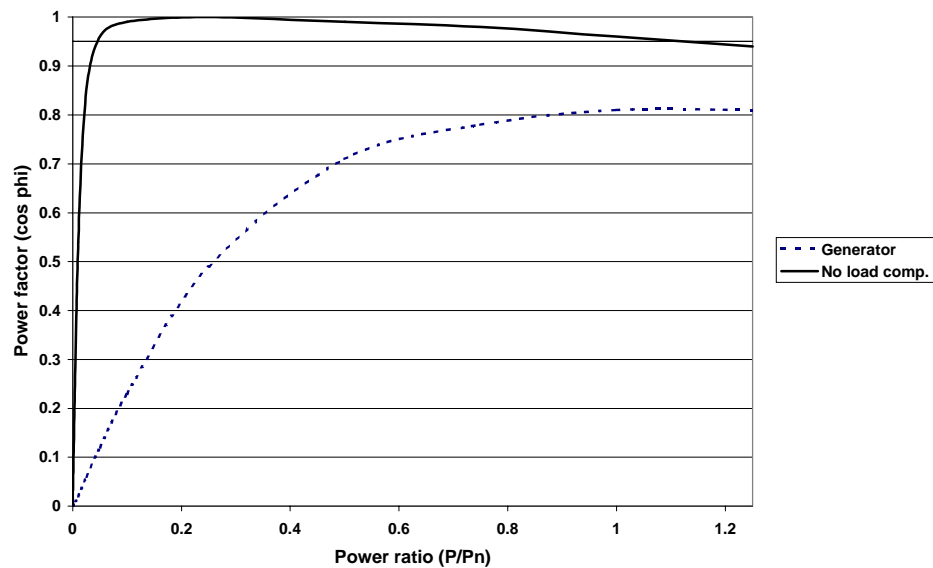

Figure 29. The power factor versus the active power production.

Figure 29 is based on data for a 225 kW Siemens generator, installed in a VESTAS pitch controlled wind turbine. The consumption of reactive power when the generator is idling at synchronous speed is calculated to be 96 kvar, and it is 163 kvar at rated production. With no-load compensation, the ratio between reactive power and active power has been calculated to 0.30 at rated production, corresponding to a power factor of 0.96.

Due to differences in the leakage reactances, different generators are not identical considering the consumption of reactive power. This can e.g. be seen from the measurements of reactive power in individual wind turbines in Figure 8. The ratio between reactive and active power, at rated production and with no-

load compensation, is for most induction generators in wind turbines in the interval from 0.2 to 0.35. This means that a typical generator can be expected to have a power factor between 0.98 and 0.94, at rated production and with no-load compensation.

6.3.2 Capacitors

The capacitor bank in Figure 29 has a rating of 100 kvar. It is noticed from the figure that the power factor is decreasing rapidly towards zero when the active production is less than 5 % of P_n . It is impossible to obtain perfect no-load compensation with a unity power factor at the lowest production levels, because of losses in the generator and uncertainties in the rating of the capacitor and other components. The low power factor reflects the ratio between a very low active power production compared to a low reactive power consumption or production (in case of a small overcompensation in the no-load situation).

The tolerances of the capacitance in a capacitor bank can be as high as -5% to $+15\%$ for units up to 100 kvar, and 0% to $+10\%$ for units above 100 kvar, according to IEC 831-1 [13]. These tolerances allow a 100 kvar capacitor bank to differ from 95 kvar to 115 kvar. The difference in the power factor for a 100 kvar capacitor bank, taking the tolerances of the capacitor into account, is illustrated in Figure 30.

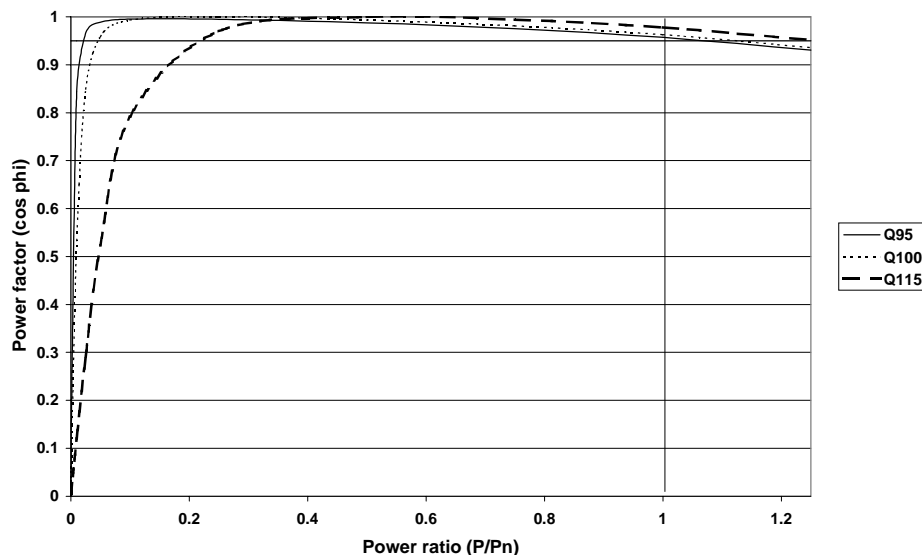

Figure 30. The power factor versus the active power production. The power factor for a 225 kW generator with 95 kvar, 100 kvar and 115 kvar compensation.

Above $0.2 P_n$ overcompensation improves the power factor, but at low active production overcompensation reduces the power factor significantly, because of a small (15-20 kvar) reactive production from the capacitor bank.

Capacitors are sold in steps with a certain number of kvar between each step which makes it impossible to achieve perfect no-load compensation, even if there were no tolerances on the capacitor rating.

6.3.3 Transformer

Wind turbines are connected to the medium voltage network via a traditional distribution transformer. The transformer needs reactive power like the induction generator. Again the reactive power must be supplied from the grid. Table

2 shows the consumption of active and reactive power of typical distribution transformers.

Table 2. Consumption of active and reactive power for typical transformers.

S [kVA]	e_r [%]	e_x [%]	i_o [%]	P_o [kW]	Q_o [kvar]	P [kW]	Q [kvar]
250	1.31	4.31	0.9	0.35	2.22	3.63	12.99
400	1.16	4.66	0.9	0.60	3.55	5.24	22.19
630	1.03	5.03	0.7	0.90	4.32	7.40	36.02
800	0.97	5.24	0.6	1.09	4.67	8.83	46.59
1000	0.91	5.44	0.5	1.19	4.86	10.32	59.26

- S : transformer rating
 e_r : active component of short-circuit voltage
 e_x : reactive component of short-circuit voltage
 i_o : current when the transformer is not loaded, expressed in per cent of the full load current
 P_o : active losses for the transformer at no-load
 Q_o : reactive consumption for the transformer at no-load
 P : active losses at full load
 Q : reactive consumption at full load.

The figures in Table 2 show that the consumption of reactive power in a transformer must be taken into consideration, although the reduction of the power factor is relatively limited. The consumption of reactive power in a transformer at full load is approximately 6 % of the rated power. Transformers with higher e_x values than the typical transformers in Table 2 will consume correspondingly more reactive power.

Figure 31 illustrates the same situation as described in connection with Figure 29, but Figure 31 includes the total power factor for both the generator and the transformer. Four cases of power factors versus power ratio are shown in Figure 31:

- A generator without compensation.
- A generator with no-load compensation.
- A generator and a transformer without any compensation.
- A transformer and a no-load compensated generator.

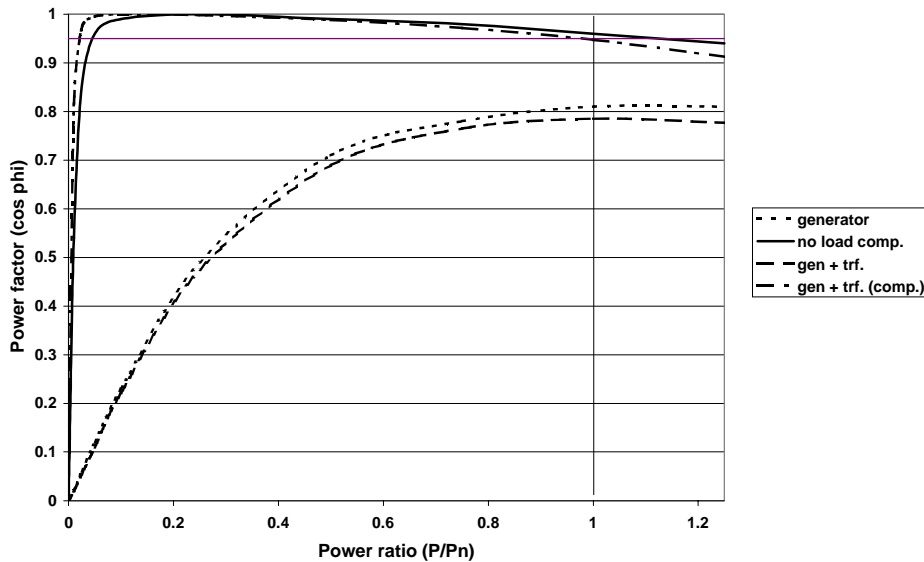

Figure 31. The power factor versus the produced active power. 225 kW wind turbine, 250 kVA transformer and a 100 kvar capacitor bank.

Notice that the power factor ($\cos \phi$) at $P/P_n = 1$ is above 0.95 if the generator is no-load compensated, and the consumption of reactive power in the transformer is disregarded. On the other hand the power factor is just below 0.95 at $P/P_n = 1$, when the consumption of reactive power in the transformer is included in the power factor calculation of the no-load compensated generator.

The consumption of reactive power in the transformer is dependent of both transformer rating and the actual load. In the example illustrated in Figure 31, a 250 kVA transformer was used for a 225 kW wind turbine.

A permanently full load compensated transformer will imply production of reactive power to the grid (overcompensation) when the wind turbine is connected but in a no-load position. This is illustrated in Figure 32, which shows three different cases:

- The power factor for the no-load compensated generator (similar to the curve in Figure 29 and Figure 31).
- The power factor for the no-load compensated generator, with a non-compensated transformer (similar to the curve in Figure 31).
- The power factor for the no-load compensated generator, with a full load compensated transformer (not illustrated in Figure 31).

The negative impact on the power factor at low production, when the transformer is full load compensated, could be avoided, if the capacitor banks were connected in steps depending on the actual power production.

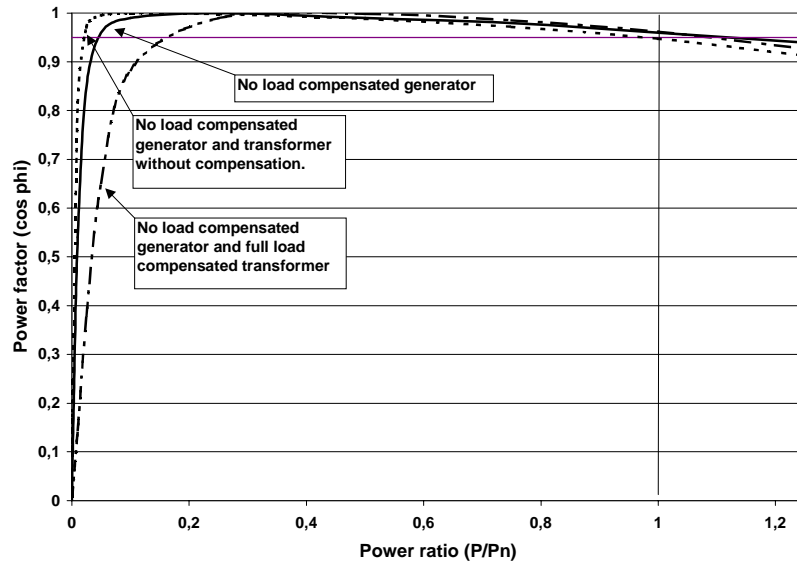

Figure 32. The power factor versus the power ratio. Different cases of compensation.

6.3.4 Steady state voltage

In clause 3.4.3 it is shown that the voltage on the high voltage level has been measured with steady state values 15 % below rated during peak load periods. The voltage on the wind turbine terminals will be influenced by a similar voltage change if the wind turbine is connected to a substation without automatic tap changers. In addition to that, the wind turbine will be influenced by voltage changes due to the voltage profiles in the feeder and the substation.

Figure 26 showed the voltage influence on the reactive power consumption of the induction generator only. As described in clause 5.1, a reduction of the voltage level at the generator terminals will lead to an increased current through the generator leakage reactances, because of the unchanged active power production. A smaller magnetising current counterbalances the increased consumption of reactive power in the leakage reactances to a certain extent. The power factor of the generator begins to decrease significantly when the voltage is below 90 % of the nominal voltage.

A low voltage will have a significant effect on the power of the capacitor bank according to (3).

$$Q_c = U^2 \cdot (C_c \cdot 2 \cdot \pi \cdot f) \quad (3)$$

- Q_c : The actual reactive power [var] of the capacitor bank
- U : The voltage [V] in the connection point of the bank
- C_c : The capacitance of the capacitor bank [Farads]
- f : The frequency in Hz.

It is seen that the reactive power production from the capacitor bank is reduced when the voltage decreases. The reduction is significant, as a reduction of the voltage level corresponding to $U = 0.9 \cdot U_n$, will result in a reduction of the reactive power production of the capacitor bank from Q_{cn} to $0.9^2 \cdot Q_{cn} = 0.81 \cdot Q_{cn}$.

Figure 33 shows how the power factor ($\cos \varphi$) on the wind turbine terminals is affected when the voltage level is decreasing. The power factor is shown both

with and without reactive power compensation, at rated active production and with a frequency of 50 Hz, but excluding the transformer consumption.

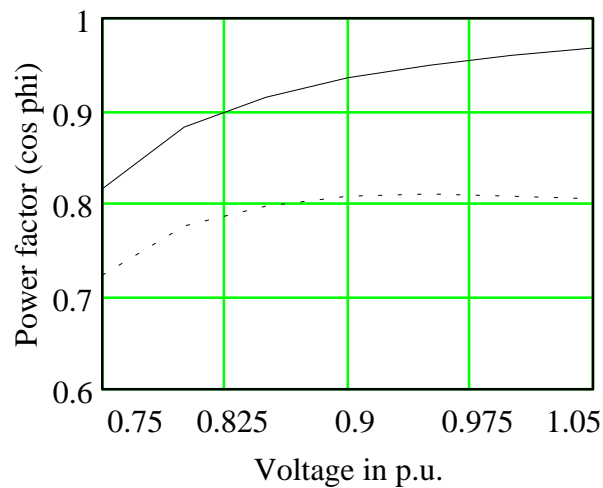

Figure 33. The power factor ($\cos \varphi$) versus the voltage level U in p.u. Solid curve: with reactive power compensation. Dotted curve: without reactive power compensation.

6.3.5 Frequency

A frequency below the 50 Hz will increase the reactive power consumption in the generator, and reduce the power of the capacitor bank, according to (3). A no-load compensated 225 kW wind turbine will consume approximately 65 kvar at rated active production and at a frequency of 50 Hz. At 48 Hz and at the same active production, the consumption of reactive power is increased to 70 kvar. This relatively small change in the reactive consumption results in a change of the rounded power factor from 0.96 to 0.95.

Figure 34 shows the power factor versus the frequency. Rated active production and voltage are used in all calculated points. It is seen that the influence of the frequency on the power factor at rated power is marginal, compared to the influence of the voltage.

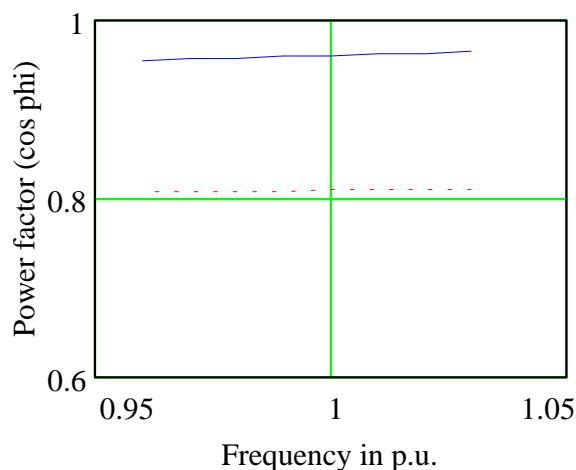

Figure 34. The power factor ($\cos \varphi$) versus the frequency f in p.u. Solid curve: with reactive power compensation. Dotted curve: without reactive power compensation. $P = 225$ kW and $U = 400$ V in all points.

6.3.6 Voltage and current unbalance

The consequences for the power factor when the wind power installation is exposed to voltage unbalance is briefly described in the following text.

The power factor has been analysed for a case with a 3 % voltage unbalance, calculated on the basis of the phase to phase voltages. The voltage in two of the phases was 8.5 % lower than U_n . The phase angles between the three phases were unchanged and equal to 120° .

The power factor is analysed in two points. The first point is at the generator terminals (no reactive power compensation). The second point is the point of common coupling (PCC), i.e. the point of connection to the grid. With the voltage unbalance given above, the unbalance in the current in the three phases is 11 % at the generator terminals, while the corresponding current unbalance at PCC is 12 %.

The resulting power factor for each phase and in total is shown in Table 3. The voltage is lower than U_n in phase b and c. The active power production (P) is close to nominal.

On the basis of this case it is concluded that the three-phase power factor is not reduced significantly if a moderate voltage unbalance occurs in the grid.

Table 3. The power factor ($\cos \varphi$) for each phase and in total in a situation with voltage and current unbalance. $P \approx P_n$.

Point	Phase a	Phase b	Phase c	Total
Generator terminals (no reac. power comp.)	0.77	0.86	0.81	0.81
PCC (reac. Power comp.)	0.93	0.98	0.98	0.96

6.3.7 Summary of effects

The previous clauses have shown the following influences on the power factor, which is obtained by no-load compensation of induction generators with capacitors:

- Induction generators can have a power factor between 0.98 and 0.94 at rated production due to different leakage reactances.
- Tolerances of the capacitors can cause the power factor to vary from 0.96 to 0.98 at rated power, and much larger differences in the power factors are seen below 20 % power production.
- A standard transformer with an e_x value close to 4.5 % will reduce the power factor from 0.96 at the wind turbine terminals to 0.95 at the metering point on the MV feeder.
- A low voltage, 10 % below rated, will cause the power factor at rated production to decrease from 0.96 to approximately 0.94.
- The frequency has a minor influence on the power factor, but the example showed that the rounded power factor will change from 0.96 at 50 Hz to 0.95 at 48 Hz.
- Voltage unbalance has very little influence on the power factor, e.g. the rounded value of 0.96 with balanced voltages is maintained with 3 % unbalance.

6.4 The obtainable monthly average power factor

This clause deals with the possibilities of achieving a high monthly average of the power factor, even if the voltage and the frequency cannot satisfy the design criteria.

Figure 35 shows the power factor versus the active power production, when the voltage is reduced to 90 % of U_n and the frequency is 48 Hz. The power factor is shown with and without reactive power compensation, and with and without the reactive power consumption of the transformer.

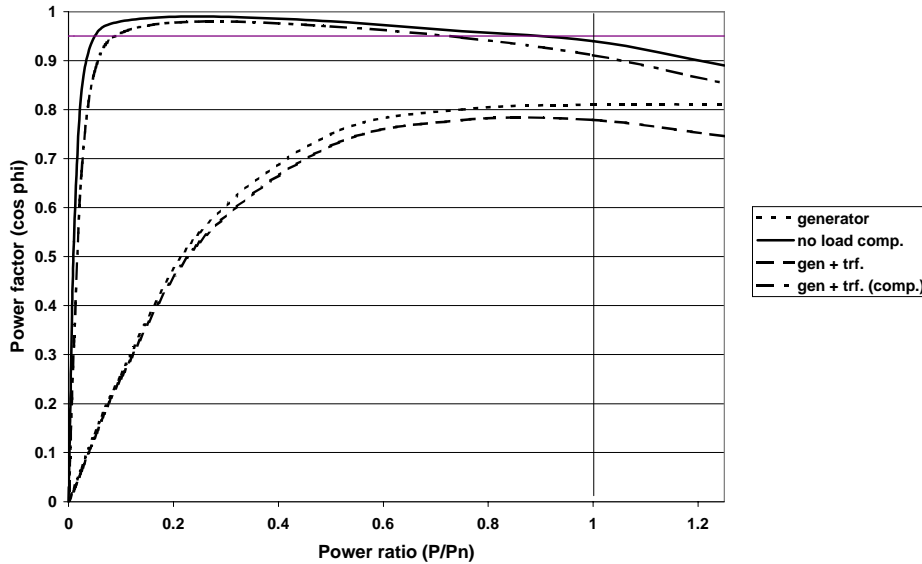

Figure 35. The power factor versus the produced active power. 225 kW wind turbine, 250 kVA transformer and a 100 kvar capacitor bank. $U = 0.9$ p.u., $f = 48$ Hz.

From Figure 35 it is seen that the power factor on the primary side of the distribution transformer, is below 0.95 when the power ratio (P/P_n) is larger than 0.75. A small overcompensation would improve the power factor at rated active production. The problems with reactive production at low wind speed in the case of overcompensation could be solved, if one capacitor bank is switched off at low production, e.g. when 50 % P_n is reached. This type of overcompensation is used in some grids, but it implicates more frequent capacitor switchings. More frequent switchings reduces the lifetime of that capacitor bank, if the same type of contactors are used.

The actual consumption of reactive energy (kvarh) in the low wind periods is low, but since a very small amount of active energy is compared with a small amount of reactive energy, there is a risk of a power factor below 0.95. With the data available for this project, it is not possible to establish whether or not; there is a risk of a whole month with an average power factor below 0.95, as a result of low wind speeds most of the time.

Figure 35 shows which power factor it is possible to achieve at a certain active production. As the wind speed is always changing, the active power production changes too, and with that the power factor. It is possible to assess a monthly average power factor ($PF_{average}$) from the accumulated active and reactive energy according to (4).

$$PF_{average} = \cos \left(\arctan \left(\frac{\Delta \text{kvarh}}{\Delta \text{kWh}} \right) \right) \quad (4)$$

$\Delta k\text{varh}$ and $\Delta k\text{Wh}$ are the measured change in the reactive and active energy in the considered period.

The measured kvarh and kWh during a certain period will of course depend on the actual wind situation. In order to illustrate this, an average power factor has been calculated for a specific time-series of wind speeds. The time-series was measured in Muppandal over a 3 days period in the high wind season August 1999. Based on the measured wind speed data, a Weibull distribution $p(W)$ for the wind speed W was estimated according to (5).

$$p(W) = \left(\frac{A}{C^A} \right) \cdot W^{(A-1)} \cdot \exp \left(- \left(\frac{W}{C} \right)^A \right) \quad (5)$$

The estimate gave a scale parameter $A = 12$ m/s and a shape parameter $C = 6$.

The relation between power factor and active production used in the example correspond to Figure 35, i.e. a voltage level of $0.9 \cdot U_n$, a frequency of 48 Hz and including the consumption of reactive power in the transformer. Except the capacitor, which was in this case equal to 96 kvar, i.e. 4 % below the one in Figure 35.

This particular example showed that the average power factor was $\cos \varphi = 0.945$. The result of this small example indicates that the average power factor for a typical generator may get below 0.95 in some periods. In many respects, this example is a worst case consideration, because of the permanently low voltage and frequency, and because of a capacitor size below the 100 kvar. But the example indicates, that a power factor below 0.95 is possible, even if all wind turbines are properly compensated.

A safer limit for the monthly average power factor would be 0.92. If the power factor is below 0.92, it is a strong indication that the installation is not sufficiently compensating the reactive power. This would most likely be due to faulty capacitors, but other components could also effect, e.g. a step-up transformer with excessively high reactive power consumption.

6.5 Requirements for a shunt connected power capacitor

6.5.1 General

Capacitors are sensitive to overvoltage, harmonics and high temperatures. Large overvoltages can reduce the capacity. Furthermore, the lifetime of capacitors is reduced, if they are continuously exposed to a high voltage level, overvoltages, harmonics or high temperatures.

The standard IEC 831-1 [13] and IEC 931-1 [14] specify requirements to power capacitors. The two standards cover shunt connected power capacitors, divided into the self-healing and the non self-healing type, respectively. Only requirements in the context of the voltage level, the maximum current, harmonics and the temperature are included in the following text. These requirements are identical in the two standards.

6.5.2 Overvoltages

IEC 831-1, clause 9 specifies routine tests as well as a type test for short term overvoltages of power capacitors:

- “9.1 Routine test: Each capacitor shall be subjected to an ac test at $U_t = 2.15 U_n$ for a minimum time of 2 s. During the test, no permanent puncture or flashover shall occur. Self-healing breakdowns are permitted.” (U_n is the rated rms voltage of the capacitor).
- “9.2 Type test: Each capacitor shall be subjected to an ac test at $U_t = 2.15 U_n$ for 10 s. During the test, no permanent puncture or flashover shall occur. Self-healing breakdowns are permitted.”

The maximum permissible voltages are specified in IEC 831-1, clause 20 according to Table 4. “It is assumed that overvoltages higher than $1.15 U_n$ occur 200 times in the life of the capacitor.”

Table 4. The maximum permissible voltage for a shunt connected power capacitor.

	Voltage factor x U_n (rms)	Maximum duration
Power frequency	1.00	Continuous
Power frequency	1.10	8 h in every 24 h
Power frequency	1.15	30 min in every 24 h
Power frequency	1.20	5 min
Power frequency	1.30	1 min

Switching voltages are treated in IEC 831-1, clause 20.2 as follows:

- “The switching of a capacitor bank by a restrike-free circuit breaker usually causes a transient overvoltage, the first peak of which does not exceed $2\sqrt{2}$ times the applied voltage (rms value) for a maximum duration of $\frac{1}{2}$ cycle. About 5000 switching operations per year are acceptable under these conditions...”
- “In the case of capacitors that are switched more frequently, the values of the overvoltage amplitude and duration and the transient overcurrent shall be limited to lower levels...”

6.5.3 Current limits

The maximum permissible current in the capacitor is specified in IEC 831-1, clause 21:

- “Capacitor units shall be suitable for continuous operation at an rms line current of 1.3 times the current that occur at rated sinusoidal voltage and at rated frequency, excluding transients. Taking into account the capacitance tolerances of $1.15 C_n$, the maximum current can reach $1.5 I_n$.”

6.5.4 Temperature limits

Capacitors are classified in temperature categories in IEC 831-1, page 17, according to Table 5.

Table 5. The maximum temperatures for the four categories of ambient temperature (outdoor installations).

Category	Ambient temperature °C		
	Maximum temp.	Highest mean over any period of 24 h	1 year
A	40	30	20
B	45	35	25
C	50	40	30
D	55	45	35

In outdoor installations, the figures in Table 5 are applied directly. In an indoor installation, the air temperature, the ventilation and/or choice of capacitor shall be such that the limits in Table 5 are maintained. The cooling air temperature in such an installation shall not exceed the temperature limits in Table 5 by more than 5 °C.

On operating temperatures, the following is specified:

- “30.1 General: Attention should be paid to the operating temperature of the capacitor, because this has a great influence on its life. In this respect, the temperature of the hot spot is a determining factor, but it is difficult to measure this temperature in practical operation. Temperature in excess of the upper limit accelerates electrochemical degradation of the dielectric.”
- “30.3 High ambient air temperature: Symbol C capacitors are suitable for the majority of applications under tropical conditions. In some locations, however, the ambient temperature may be such that a symbol D capacitor is required. ...”.

6.5.5 Harmonic and interharmonic disturbances

According to IEC 831-1, clause 37.2.1:

- “Capacitors shall be suitable for continuous operation in the presence of harmonics and interharmonics within the limits required in clauses 2 and 3 of IEC 1000-2-2.”

Compatibility level for individual harmonic voltages, THD, THD_w and interharmonics in low voltage networks according to IEC 1000-2-2 [15]:

Table 6. Compatibility level for individual harmonics according to IEC 1000-2-2.

Odd harmonics non-multiple of 3		Odd harmonics multiple of 3		Even harmonics	
Harmonic order h	Harmonic voltage %	Harmonic order h	Harmonic voltage %	Harmonic order h	Harmonic voltage %
5	6	3	3	2	2
7	5	9	1.5	4	1.
11	3.5	15	0.3	6	0.5
13	3	21	0.2	8	0.5
17	2	>21	0.2	10	0.5
19	1.5			12	0.2
23	1.5			>12	0.2
25	1.5				
>25	0.2 +0,5*25/h				

The total harmonic distortion is defined in IEC 1000-2-2 according to equation (3), clause 0 above. The compatibility level for the total harmonic distortion (THD%) in IEC 1000-2-2 is 8 %.

The weighted distortion factor THD_w defined in (6) is important when capacitors are considered. The compatibility level for THD_w ≈ 0.84 at nominal voltage, and 0.63 at 110 % U_n.

$$THD_w = \sqrt{\sum_2^N \left(h \cdot \frac{U_h}{U_1} \right)^2} \quad (6)$$

At present, the compatibility level for interharmonics is 0.2 %, based on the response level for ripple control receivers.

6.6 Simulation of overvoltages

6.6.1 Cases with overvoltages

Switching overvoltages will mainly occur in one of the three following cases:

- Connection of the capacitor to the grid with the wind turbine already connected.
- Normal disconnection of the capacitor banks, including disconnections caused by a low level of voltage and frequency in the grid.
- Disconnection of the capacitor bank in an island situation.

The first two cases mentioned above represent common switching operations. These switchings will occur in any situation where the capacitor is connected according to the pre-programmed connection sequence, or the capacitor is disconnected just before the disconnection of the wind turbine, as a consequence of low wind speed, high wind speed or disturbing conditions in the grid, e.g. voltage unbalance or a low voltage level.

Disconnection of the capacitor bank in an island situation will always occur as a result of a fault condition in the grid. The fault will trip the nearest relays, which will lead to a disconnection of the faulted parts of the network. In some situations, this could lead to a separation of wind turbines from the high voltage system. These wind turbines now form an island with no other production present.

Islanding is a complicated situation. The reactive power for the generator is delivered from the capacitor, and since there is no place to put surplus of active energy, the rotor blades will accelerate and create an unstable situation with increasing frequency and voltage. It is crucial that the capacitor is disconnected and discharged very quickly when an island situation is detected.

As mentioned in clause 2.2, outages in the grid e.g. due to insufficient capacity have been the case very frequent. The outages force the wind turbines to stop. These stops can be characterised as normal disconnections, but a high number of switchings are likely to affect the lifetime of the capacitor banks.

6.6.2 Simulation model

As a part of the current project the overvoltages resulting from the switching of capacitor banks have been simulated in EMTP-ATP (EMTP: Electro-Magnetic Transient Program, ATP: Alternative Transients Program). Different cases of switchings, as described in the previous part, have been examined.

Figure 36 and Figure 37 show the models used for the simulations, in a simplified form. The models can be characterised as quasi stationary. Real transient simulations would require much more advanced high frequency models.

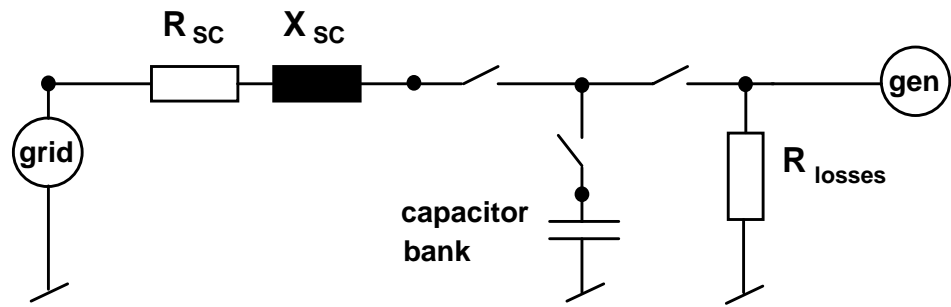

Figure 36. Model of the electrical grid, in a simplified form.

From Figure 36, it is seen that the electrical grid consists of a voltage source, a short circuit impedance, a capacitor bank, a resistance representing losses and active consumption in the installation, the necessary switches and finally an induction generator.

A wind turbine model is connected to the “gen” point in the grid model in Figure 36. The electrical equivalent of this wind turbine model is shown in Figure 37, with marking of the “gen” connection point. The electrical equivalent of the mechanical system is based on the following duality between mechanical and electrical parameters:

- Torque T is equivalent to current i .
- Rotation speed ω is equivalent to voltage v .
- Inertia J is equivalent to capacitance C .
- Spring constant k is equivalent to the inverse inductance $1/L$.
- The gear is equivalent to a transformer.

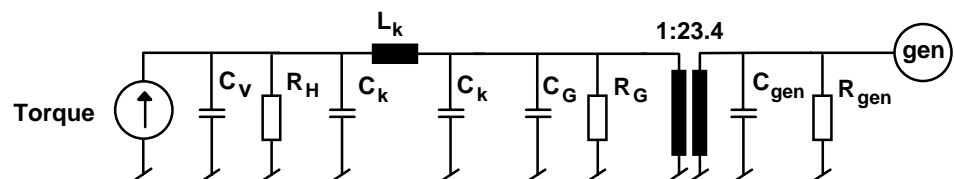

Figure 37. Model of the mechanical system, electrical equivalent.

- | | |
|-------------|---|
| C_v : | Rotor inertia. |
| R_H : | Losses in the main bearings (estimated to 1 % of the mechanical power). |
| C_k : | Transmission inertia. |
| L_k : | Stiffness of the main shaft. |
| C_G : | Gear inertia. |
| R_G : | Losses in the gear (estimated to 3 % of the mechanical power). |
| C_{gen} : | Generator inertia. |
| R_{gen} : | Mechanical losses in the generator. |

The rotor inertia is considered to be much larger than both the transmission inertia and the gear inertia. This makes it possible to neglect both C_k and C_G . The parameters for the model (generator and mechanical system) used in the simulations are listed in Appendix B.

6.6.3 Connecting the capacitor bank to the grid

Figure 38 shows the voltage on the generator terminals (one phase) when a capacitor is connected to a grid with a 225 kW wind turbine. The size of the ca-

capacitor bank corresponds to no-load compensation. The voltage across the capacitor bank is similar to the voltage in Figure 38, except for the period where the capacitor is not connected, i.e. the first 100 ms.

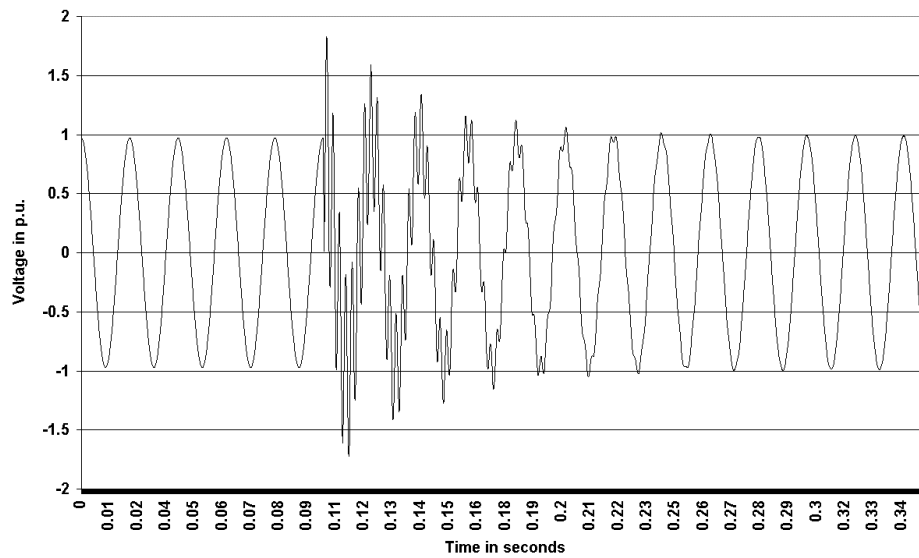

Figure 38. The voltage seen from the generator terminals when a capacitor bank, with a size corresponding to no-load compensation, is connected to the grid.

When the capacitor is switched in, a RCL circuit is formed, which will cause an oscillatory response with a frequency of approximately 350 Hz and a duration of 100 ms. It is noticed that the overvoltage is approximately 1.8 times the peak value of the voltage. The voltage in Figure 38 represents the worst case where the connection takes place at maximum voltage.

6.6.4 Disconnecting the capacitor bank from the grid

Disconnection of the capacitor when the grid is still present (not islanding) is not a problem with regard to overvoltages. This is clear from Figure 39, where the capacitor bank is disconnected from the grid at 100 ms. It is noticed that no overvoltage occurs. When the wind turbine is disconnected at 300 ms, the voltage on the mains of the generator starts to decrease towards zero, due to the lack of reactive power. It is no longer possible to keep up a magnetised main reactance in the generator.

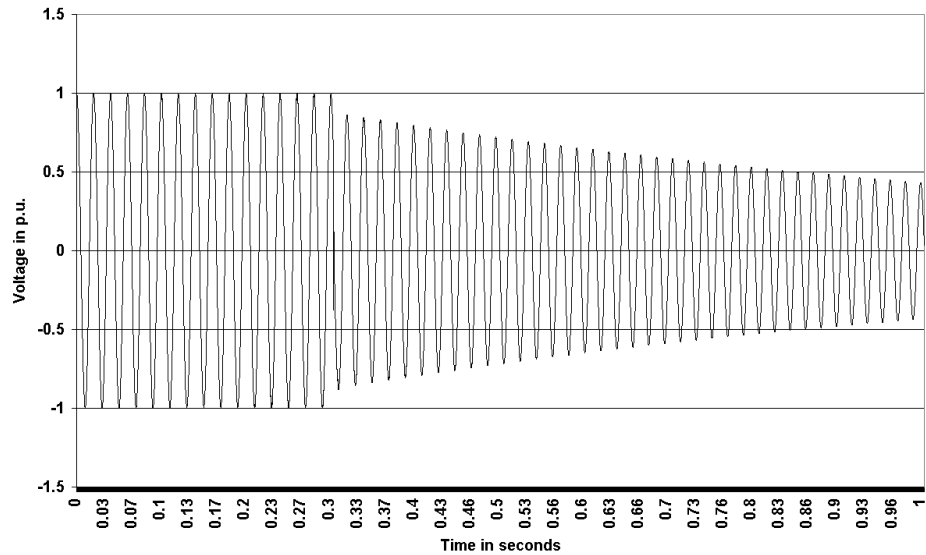

Figure 39. The voltage on the generator terminals. Disconnection of the capacitor bank at 100 ms, and disconnection of the wind turbine from the grid at 300 ms.

6.6.5 Disconnecting the capacitor bank – island situation

Figure 40 illustrates the voltages on the generator terminals in a situation where the generator (wind turbine) and the capacitor bank form an island, isolated from the public electricity supply system.

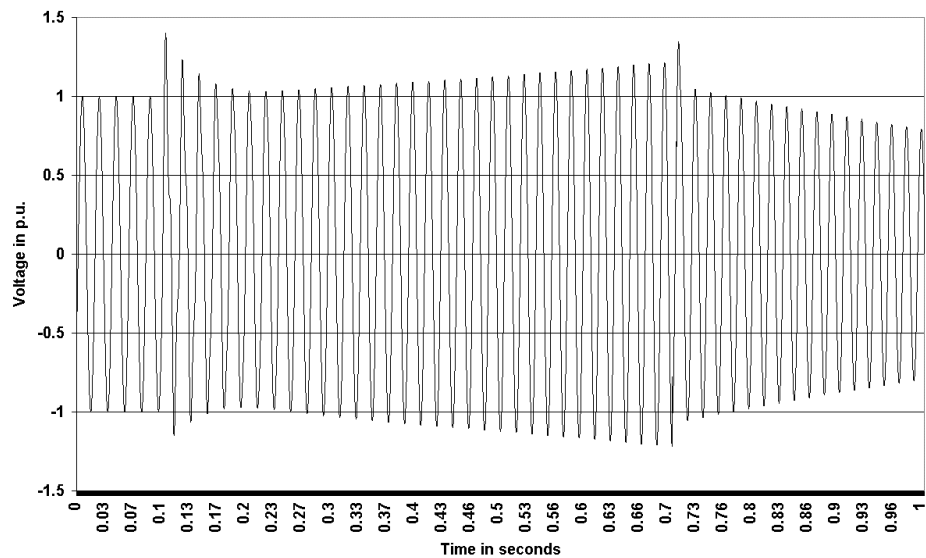

Figure 40. The voltage on the generator terminals. Disconnection of the grid at 100 ms (islanding), and disconnection of the capacitor bank at 700 ms.

The disconnection of the grid at 100 ms, which consequently leaves the wind turbine and capacitor bank in an island situation, will change the conditions of the network seen from the generator terminals. The change will force the leakage reactance in the generator to deliver stored energy. The result is a voltage

peak immediately after the disconnection of the grid. This overvoltage will decrease again within a few periods after the grid has disappeared.

A small reactive overcompensation is quite normal. Overcompensation in an island means there is more reactive power available than necessary. An overcompensation of the main reactance in the generator will lead to an increasing voltage in the island. From Figure 40 it is noticed that the voltage has reached 1.2 times the nominal value after 600 ms. In this case there is four per cent overcompensation. An even larger overcompensation will result in a higher overvoltage. Therefore, it is important to disconnect the capacitor banks as fast as possible after the island situation arises. This can normally be done with overvoltage relays with a setting that disconnects the capacitor bank in less than 100 ms if the voltage level is above $1.15 \cdot U_n$.

The capacitor bank is disconnected at 700 ms, and then the voltage drops towards zero as seen in Figure 40. In Figure 41, the capacitor bank is disconnected 200 ms after the grid disappears. It is obvious that the overvoltage, as a result of the overcompensation, is reduced significantly, because of the faster disconnection compared to the situation in Figure 41.

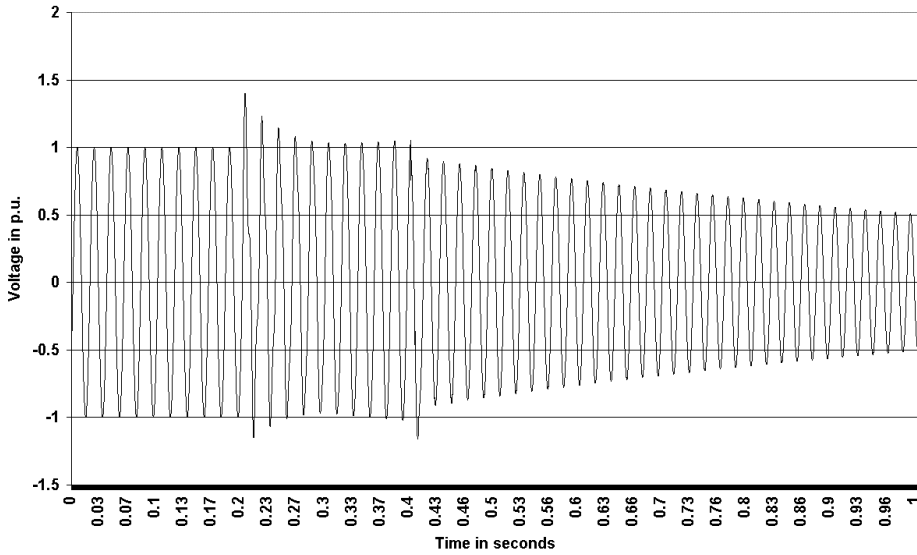

Figure 41. The voltage on the generator terminals. Disconnection of the grid at 200 ms (islanding), and disconnection of the capacitor bank at 400 ms.

Finally, Figure 42 shows the voltage on the generator terminals when the grid disappears at 200 ms and the capacitor bank is disconnected immediately after at 225 ms. In this case the only overvoltage present is the one caused by the leakage reactances of the generator.

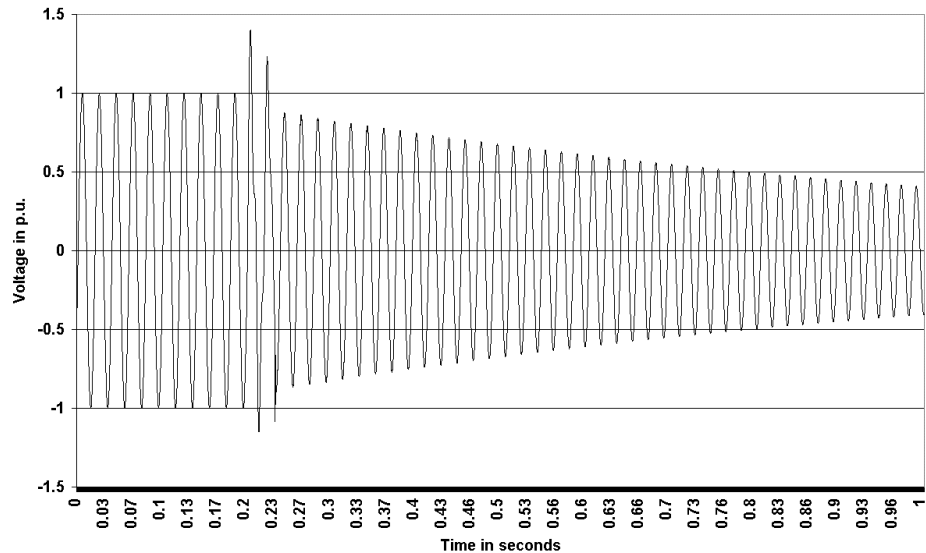

Figure 42. The voltage on the generator terminals. Almost simultaneously disconnection of the grid (200 ms) and the capacitor bank (225 ms).

6.7 Summary

6.7.1 General

The considerations about capacitor banks in wind turbines for compensation of reactive power are summarised below.

6.7.2 Power factor

A typical no-load compensated wind turbine can have a power factor of 0.91 at rated production, measured at the metering point on the MV feeder, assuming worst case grid conditions of 10 % undervoltage and 48 Hz grid frequency.

The monthly average power factor will be better, because the production will not be rated during a full month. A calculated example using wind data from the windy season in Muppandal showed that the average power factor was $\cos \varphi = 0.945$. Having used worst case grid assumptions, this example indicated that the monthly average power factor will normally be better than 0.95 with appropriate no-load compensation, but a monthly average power factor below 0.95 is possible, even if the wind turbines are properly compensated.

A safer limit for the monthly average power factor would be 0.92. If the power factor is below 0.92, it is a strong indication that the installation is not sufficiently compensating the reactive power. This would most likely be due to faulty capacitors, but other components could also effect, e.g. step-up transformers with excessively high reactive power consumption.

6.7.3 Overvoltages

From the simulations of overvoltages, as a result of capacitor switchings, it can be concluded that no ordinary switchings will cause overvoltages above the recommended limit of two times the nominal voltage peak value as stated in IEC 831-1 and IEC 931-1.

The worst switching situation occurs when the capacitor bank is connected to the grid. An RCL circuit is formed, which will cause an oscillatory response with a peak of 1.8 times the rated voltage amplitude.

It is assumed that the total number of switchings (connections and disconnections) of each capacitor are less than 5000 per year. Normally, this limit will not be critical for capacitor banks designed for no-load compensation in wind turbines, but the limit can be exceeded by frequent startups, due to a combination of turbulent wind and grid outages.

If the capacitors used for power factor correction are manufactured in accordance with IEC 831-1 (or IEC 931-1) or a similar standard, switching operation should not be harmful to the capacitor banks, provided that the batteries are disconnected as soon as possible when an island situation arises.

6.7.4 Harmonics

Capacitors are sensitive to harmonic distortion in the voltage, and a high level of harmonics can be harmful to the capacitors. It is important to ensure that the 8 % total harmonic distortion and the weighted distortion factor of 0.84 are not exceeded in the point of common coupling for each capacitor bank.

The measurements of harmonics and interharmonics in clause 3.4.5 showed, that the total harmonic distortion of the voltage on the 66 kV and 110 kV levels are below the required 8 %. Likewise, the weighted distortion as defined up to the 40th harmonic is below the limit. However, if harmonics above the 40th are considered, the measured distortion in Radhapuram at the 85th harmonic would have exceeded the limit for weighted distortion. But the measurement of the high frequency distortion on the substation is imprecise, as mentioned in clause 3.4.5.

7 ASVC based compensation

7.1 General

As mentioned in clause 4.5, ASVC's are now used for reactive power compensation in a 24 MW wind farm in Denmark. The wind turbines in the wind farm use directly connected induction generators, with capacitor banks for no-load compensation in the individual wind turbines. Proceeding with capacitor compensation in the wind turbines reduces the required capacity of the ASVC's.

Connecting ASVC's to the wind farms connection points to the feeders or to the busbar in a substation makes it possible to control the power factor to unity in the point where it is connected, i.e. on the medium voltage level. Wind turbines with power converters typically control the power factor on the wind turbine terminals, i.e. on the low voltage level. Therefore, ASVCs will compensate for the reactive power consumption in the step-up transformers and feeders, and consequently obtain an even better power factor of the wind farm than with power converters in the individual wind turbines.

7.2 Control strategy

A basic configuration of the VAR compensator is shown in Figure 43. As seen in the figure, a three-phase inverter is the basic block of the advanced VAR compensator. Different control strategies are in use. The inverter using PWM technique and field orientation principle, which is an advanced technology is explained in this section.

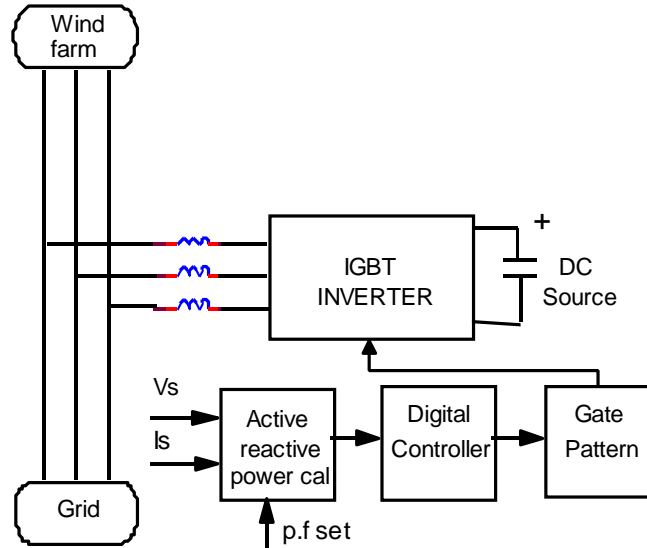

Figure 43. Static var compensator using IGBT inverter.

The control strategy adopted in the advanced SVC is a straightforward approach, by considering the utility grid as a virtual machine, and controlling the active and reactive power components using the vector control method, thus getting high dynamic performance. The integration of the utility grid voltage with respect to time yields the virtual rotating magnetic flux vector along the reference frame.

The projection of the system equations on to this rotating frame leads to the separation of the line current into two orthogonal components. The component in quadrature with the virtual flux vector is responsible for the exchange of active power. The direct axis component corresponds to the reactive power component. Decoupled and high dynamic power control is thus made possible as in the case of vector control technique applied to electrical machines.

For the implementation of the field orientation principle, the grid voltage in combination with the line side inductors are taken as quantities related to a virtual ac machine. The line side inductance and the resistance represent the stator leakage inductance and stator resistance of the machine. Similar parameters are set for the inverter, using the inverter output voltage and the line currents. Hence the phase to phase line voltages will be induced by a virtual air-gap flux. The integration of phase to phase voltage leads to virtual flux vector, which rotates with respect to the stationary frame oriented with the machine stator.

The system consists of a three phase inverter (refer Figure 43) constituted by Insulated Gate Bipolar Transistors (IGBTs). This system can be operated as a reversible rectifier so that bi-directional power flow is possible. The control function ensures the features like sinusoidal line current, definable reactive

power output, and bidirectional power flow. The active and reactive power components P and Q of the system are expressed in (7) and (8) as

$$P = \frac{3}{2L} \omega \psi_e \psi_v \sin \delta_p \quad (7)$$

$$Q = \frac{3}{2L} \omega (\psi_e \psi_v \cos \delta_p - \psi_e^2) \quad (8)$$

From the above equations it is clear that the active power can be controlled by controlling δ_p , which is the spatial angle between the grid flux vector and the inverter flux vector, ψ_e and ψ_v respectively. The reactive power Q can be controlled by controlling the inverter flux ψ_v . The user can set the reactive power reference according to the site requirements.

In the control system implementation, the vector ψ_v is controlled to have a specified magnitude and spatial position relative to the grid flux vector ψ_e . The actual values of the active and reactive power are estimated from the feedback signals of grid voltage, grid current and DC link voltage, and corrective action is taken by comparing these actual values with the set values. This cycle of operation is done at high sampling rates using a fast Digital Signal Processor based controller.

A control structure in cascade form is normally applied. This consists of an inner loop to shape the line currents according to the desired field oriented components and the quadrature component being given by an outer DC link voltage control loop, together with feed-forward techniques to allow faster transient response.

The switching frequency of the IGBTs will be around 2kHz, so that lower order harmonics are eliminated. This control strategy can be effectively employed for compensation of reactive power, reduction of flicker due to power fluctuation and attenuation of harmonics.

7.3 Connection of ASVC with the Wind farm

ASVC will be cost effective when used for group compensation, instead of connecting with individual wind turbines. A typical configuration for compensation of a group of three wind turbines is shown in Figure 44.

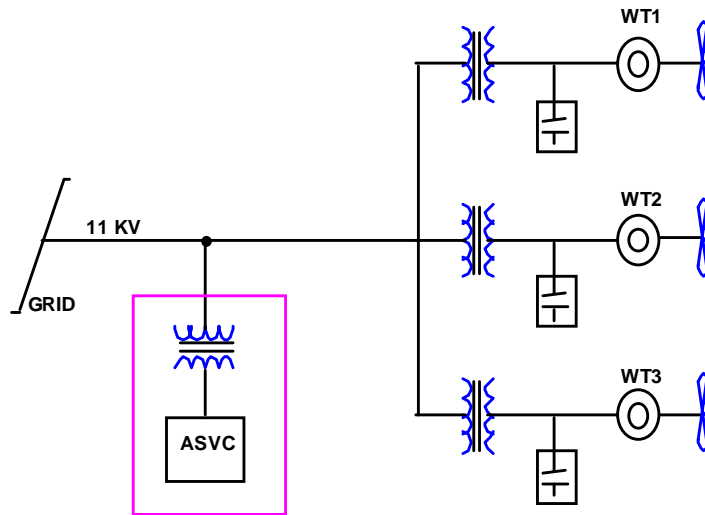

Figure 44. ASVC connection to the wind farm.

A small value of fixed capacitors sufficient to supply the constant demand of magnetizing current is connected with individual wind turbines. The reactive power demand proportional to the generated power will be instantaneously compensated by the ASVC connected in parallel at the common point of coupling. The sizing is decided taking into account the power to be compensated as well as the expected fluctuating power from the wind. High power ASVCs in the MW range of power capacity are employed for the compensation of an entire wind farm. In this case, power configurations with multilevel inverters using IGBTs or GTOs (Gate Turn off Thyristors) are used.

7.4 Summarised advantages

With the application of var compensators it is possible to maintain load voltages of the transmission network within the specified limits, and increase the power transmission capability of the lines while maintaining stability of the power system. The outcome of installing a var compensator can be summarised as a better voltage profile, reduced losses and increased stability of the system.

8 Conclusions and recommendations

8.1 Conclusions

The following conclusions are drawn, based on meetings, measurements and analyses:

- After the fast growing wind energy development in India in the early nineties, the capacity of the grids in the wind farm regions in Tamil Nadu and Gujarat was insufficient to evacuate the wind power. This has caused frequent outages of the grid and reduced the return from the wind farms. In the late nineties, the wind energy development in India slowed down, and the utilities have developed the grid capacity to an acceptable level.
- 2-3 outages a week have been measured in the windy season of 1999 on the 110 kV level. The number of outages on the wind turbine terminals will be higher, because faults in substation and the power collection system in the wind farm will add to the faults, which can be measured on the 110 kV level.
- The reactive power consumption of the wind farms is significantly higher in Gujarat than in Tamil Nadu. The reason for the high reactive power consumption in Gujarat is that approximately half of the capacitor banks in the wind turbines in Gujarat are defect. A conclusive reason why the capacitor banks are maintained better in Tamil Nadu than in Gujarat is, that the power factor penalty system in Tamil Nadu encourage the owners to replace defect capacitors, whereas that there are no incentives to regulate the power factor in Gujarat.
- Wind turbines with directly connected induction generators and no-load compensation with capacitor banks can normally obtain a monthly average power factor of 0.95 during the high wind season. However, due to the influence of e.g. voltage quality and tolerances of capacitors, the average power factor may be less than 0.95 in some instances, even with appropriate no-load compensation. A safer limit for the monthly average power factor is 0.92. If the power factor is below 0.92, it is a strong indication that the installation is not sufficiently compensating the reactive power. This would most likely be due to faulty capacitors, but other poor components can also reduce the power factor, e.g. step-up transformers with excessively high reactive power consumption.
- Simulations of overvoltages on capacitors due to switchings of the wind turbine have shown that no ordinary switchings will cause overvoltages above the recommended limit for capacitors in IEC 831-1 and IEC 931-1. Also islanding of wind turbines during grid outages has been simulated, and the results showed that the overvoltages will be below the limits, provided that the wind turbines are not overcompensated.
- Capacitors are sensitive to harmonic distortion in the voltage, and a high level of harmonics can be harmful to the capacitors. The limits for distortion of the capacitors are 8 % total harmonic distortion and a weighted distortion factor of 0.84.
- The measurements of harmonics and interharmonics have shown that the harmonic distortions of the voltage on the 66 kV and 110 kV levels are below the limits, including only harmonics up to 40th order according to the standards. However, high distortion levels have been measured at harmonic orders above the 40th, which could also cause damage to e.g. capacitors.
- Manually switched capacitors installed in the substations are adding to the reactive power compensation in the wind turbines in Tamil Nadu. The substation capacitors are contributing to a very good power factor as long as the wind farm production is less than 50 % of rated power.
- Wind turbines with power converters can control the power factor e.g. to unity on the wind turbine terminals. The power factor is controlled in the whole power range, and independent on voltage quality.
- Advanced static var compensators (ASVC) can be applied for group compensation of reactive power consumption from a wind farm. The ASVC

contributes to the stability of the power system, and it can smooth the voltage fluctuations.

- The measured voltage range on the 110 kV level in Muppandal is from +5% to –15 %, which exceeds the 12.5 % lower limit in IS 12360-1988 during peak load periods.
- Voltage unbalance has been identified as a problem in rural load feeders with wind turbines. The voltage unbalance has been measured to less than 2 % in all the selected wind farm substations, but measurements have not been performed on rural load feeders.
- The measured frequency range is from 51 Hz to 48 Hz. Consequently, the lower limit is 4 % below the rated 50 Hz, which exceeds the ± 3 % frequency limit in IS 12360-1988. The large frequency variations have an unfortunate influence on the performance of stall regulated wind turbines.

8.2 Recommendations for grid connection

It is recommended to practice the following for the grid connection of wind farms in India:

- Develop sufficient capacity of the grid to evacuate the maximum power output from the wind farms, corresponding to installed rated capacity. This is to ensure a full return of the wind power in the windy seasons.
- Use automatic tap changers or other regulation schemes, to ensure that the steady state voltage on the wind turbine terminals can be kept within acceptable range, despite the measured large variations in the steady state voltage on the high voltage level.
- Use dedicated feeders to the wind farms, to avoid excessive voltage unbalance and increase the availability of the grid.
- The voltage unbalance in the point of common coupling (PCC) of a wind farm or a single wind turbine should not exceed 2 %.
- Install additional reactive power compensation at medium and high voltage levels to compensate for the considerable amount of reactive power absorbed by loads, and the residual reactive power consumption of wind turbines.
- Use step-up transformers with ex values better than 6 %
- For installation of wind turbines with capacitors, the total harmonic distortion in the PCC shall be below 8 %, and the weighted distortion factor shall be below 0.84.

8.3 Recommendations for wind turbines

It is recommended to practice the following for the grid connection of wind farms in India:

- Capacitor compensation of the individual wind turbines with directly connected induction generators, corresponding to the reactive power required by the generator at no-load. Full range compensation of the reactive power is possible, but it is not recommended, because shutdowns in island situations can create high overvoltages in the wind turbine installation.
- Compensation of the reactive power consumption of the step-up transformer
- Capacitors must fulfil the requirements in IEC 831-1, especially with respect to the influence of overvoltage and temperature.

8.4 Operation and maintenance

Faulty capacitors in wind turbines cause unnecessary losses and other problems on the grid. It is therefore recommended to use a practice, which ensures the maintenance of the capacitors.

One way to encourage for maintenance of capacitors, which has proven to work in Tamil Nadu, is to use a payment system for reactive power consumption.

The above analyses have shown that with the recommended no-load compensation, wind turbines with directly connected induction generators normally have a monthly average power factor better than 0.95. However, during the high wind season, the average power factor may be below 0.95, even with proper no-load compensation. A power factor below 0.92 indicates more evident, that the compensation is faulty. Table 7 illustrates these indications of the monthly average power factor.

Table 7. Indications of monthly average power factors during the high wind season for wind turbines with directly connected induction generators and no-load compensation.

Monthly average power factor	Indication
0.95 – 1.00	Appropriate reactive power consumption
0.92 – 0.95	Grey zone
< 0.92	Faults in compensation

A high payment for all power factors below 0.95 could therefore encourage the owners to overcompensate the wind turbines, which can cause other problems. Payments for reactive power with average power factors below 0.92 will provide incentive to replace faulty capacitors, without encouraging the owners to overcompensate.

Acknowledgement

The project team thanks the government officials, electricity boards, nodal agencies, wind turbine manufacturers and wind farm owners in India, and the Danish wind turbine industry, who have all met us with kindness and contributed with very useful information to the project.

References

1. B.Rajsekhar, F.VanHulle and D.Gupta. Influence of Weak Grids on Wind Turbines and Economics of Wind Power Plants in India. Wind Engineering Vol 22 No 3 1998.
2. P.Sørensen, P.H.Madsen, K.K.Jensen,, A.K.Unnikrishnan and Z.V.Lakaparampil. Field study of Power Quality and integration of wind farms in weak grids in India. Risø-I-1368. March 1999.

3. P.Sørensen, A.K.Unnikrishnan and Z.V.Lakaparampil. Measurements of Power Quality of wind farms in Tamil Nadu and Gujarat. Workshop on Wind Power Generation and Power Quality Issues. Proceedings. Trivandrum, November 1999.
4. Wind Power Development in India. Towards Global Leadership, Ministry of Non-conventional Energy Sources, Government of India, November 1998.
5. Indian Renewable Energy Development Agency. "Technical specifications" for wind power projects.
6. European Standard EN50160. Voltage characteristics of electricity supplied by public distribution systems. November 1994
7. IS 12360-1988. Voltage Bands for Electrical installations Including Preferred Voltages and Frequency.
8. DRAFT IEC 61400-21. Power quality requirements for grid connected wind turbines. Updated CDC September 1999.
9. K.A.Fathima, , Z.V.Lakaparampil, A.K.Unnikrishnan. Workshop on Wind Power Generation and Power Quality Issues. Proceedings. Advanced Static VAR compensators. Trivandrum, November 1999.
10. R. Stöber, N. Jenkins, J. Kaas Pedersen, K.H. Sjøbrink, K.O. Helgesen Pedersen and others: Power Quality Improvements of Wind Farms. ISBN No: 87-90707-05-2. ELTRA, Fredericia, Denmark. June 1998.
11. J.K.Pedersen, K.O.H.Pedersen, T.W.Rasmussen. Experience with Advanced Static Var Compensators operating in wind farms and in Laboratory in Denmark. Workshop on Wind Power Generation and Power Quality Issues. Proceedings. Trivandrum, November 1999.
12. A. Vikkelsø, K. K. Jensen and P.Sørensen. Power factor correction in weak grids using shunt power capacitors. Workshop on Wind Power Generation and Power Quality Issues. Proceedings. Trivandrum, November 1999.
13. IEC 831-1. Shunt power capacitors of the self-healing type for a.c. systems having a rated voltage up to and including 1000 V, General performance, testing and rating – safety requirements – Guide for installation and operation. Second edition 1996-11.
14. IEC 931-1. Shunt power capacitors of the non-self-healing type for a.c. systems having a rated voltage up to and including 1000 V, General performance, testing and rating – safety requirements – Guide for installation and operation. Second edition 1996-11.
15. IEC 1000-2-2, Electromagnetic compatibility (EMC). Part 2: Environment. Section 2: Compatibility levels for low-frequency conducted disturbances and signalling in public low-voltage power supply systems. First edition 1990-05.

Appendices

Appendix A Conditions in Indian states

A.1 Andhra Pradesh

A.1.1 General

The state of Andhra Pradesh presently has an installed wind farm capacity of 56 MW, of which 55 MW has been installed at the Ramagiri site. The potential sites are found in complex terrain, and wind monitoring has been carried out by NEDCAP (Non-conventional Energy Development Co-operation of Andhra Pradesh) in collaboration with IITM, Bangalore with anemometers in 10 and 25 m height. Sites have been selected with 175 W/m² in 30 m height, and sites with a potential of 1000 MW have been identified. The annual average wind speed varies from 5 m/s to 6.7 m/s with an annual average of 5.7 m/s at Ramagiri. An annual growth of wind farm capacity of 50 MW/year is expected.

Andhra Pradesh is part of the southern region also consisting of Karnataka, Kerala and Tamil Nadu whose grid is interconnected primarily on the 400 kV level. The peak load in Andhra Pradesh is approx. 5500 MW with an installed power generation capacity of 7000 MW.

A.1.2 Strategy for wind farm network integration

The strategy is to identify and develop large areas with potential larger than 50 MW. The micro-siting is emphasised and is based on mapping the area using movable mast and on WASP analysis. A 220 kV line and a 33/220 kV substation is installed in the area, and the wind farms are connected through dedicated 33 kV feeders to the substation. A limit of 10 MW per feeder and a total of 120 MW for the substation have been chosen.

The areas are found on government land, and up to 20 MW installed capacity is allotted to each investors. Projects of more than 20 MW must be installed on private land. Only wind turbines on the recommended list of MNES, i.e. wind turbines with type certificate by Risø, GL or CIWI, are allowed in the areas.

It is required to maintain a power factor of 0.95 at the substation level for grid connection. A policy has been adopted whereby the individual wind farm owner must maintain a power factor of at least 0.85 in order to avoid a penalty of 0.1 Rs/kvarh reactive energy to the electricity board. A supplementary reactive power compensation of a 132 kVAR automatically controlled capacitor bank is to be installed at the 220 kV substation, financed by the investors according to their installed capacity. If the individual wind farm power factor is between 0.85 and 0.95, reactive power is supplied centrally. If the wind farm power factor is above 0.95, no further compensation is needed. The power factor is measured at the wind farm connection point to the 33 kV feeder line to the 220/33 kV substation. The investors are credited according to their use of the central capacitor bank.

In general wind turbines with induction generators must be compensated with capacitor banks with capacity corresponding to 50 % of the rated power.

An average power factor of 0.85 shall be obtained. This limit may be increased to 0.95 in the future.

A.1.3 Grid connection procedures and responsibilities

The area and the wind farms sites are developed by NEDCAP, who interacts with the investor from application to commissioning. APSEB is responsible for the power evacuation facilities and will construct and maintain the substation and 33 kV feeders.

The investor submits his application to NEDCAP, who supplies information on the site, wind data etc. NEDCAP will also assist in identifying suppliers, supervising works and arranging for power evacuation. NEDCAP's services are valued as 1 % of the project cost.

The developer is charged 10 lakhs (10,00,000 Rs) per MW installed wind turbine capacity to cover the cost of the power evacuation facilities. Switchgear, step-down transformers and line to the individual wind turbines are the developers responsibility, and the cost will be borne by the developer.

A.1.4 Grid characteristics

The grid availability in Andhra Pradesh is 98-99 %. The nominal grid frequency is 50 Hz and may vary between 47.85 Hz and 50 Hz.

The voltage variation at the 33 kV level is -9 to +3 % of nominal value (at 33kV busbar at Ramagiri substation).

The voltage unbalance at this level is insignificant.

APSEB requires a power factor of 0.95 and has installed capacitor-banks at substations to secure the level.

1.5 % total harmonic distortion is reported for the high voltage side of substations. A similar limit is applicable for the wind farm 33 kV busbar.

A general requirement to Total Harmonic Distortion (THD) is 5 %.

A.1.5 Other observations

Comprehensive measurements have been carried out of the reactive power needs of the wind farms at Ramagiri during different month. On this basis the capacity of the central reactive power compensation can be estimated. While the present strategy for grid connection of wind farms solves the problem of reactive power consumption from wind turbines with induction generators, proper documentation of the need for reactive power for the wind turbines types is strongly needed for system design and design of compensation at the wind farm substation level. Such measurements should be part of type testing of wind turbines.

NEDCAP introduces a concept of joint sharing wind farms.

The peak production of wind farms in Andhra Pradesh is expected during July and August.

No lightning damage to the wind turbines has been observed.

A two-day seminar on power quality issues with participation of nodal agencies, state electricity boards, developers and manufacturers prior to finalisation of the present project was suggested.

A.2 Gujarat

A.2.1 General

The state of Gujarat presently has an installed wind turbine capacity of 150 MW in the private sector and 16.3 MW as government demonstration projects with a total of 650 wind turbines. Approx. 40 MW was damaged during the cyclone of May 1998. The wind farms are located near the coast, 90 MW, and further inland, 66 MW.

Annual capacity factors of 15-16 % have been observed during 1990-97 in Gujarat with a maximum of 18 %. The annual average wind speed amounts to 18-20 km/h. The high wind period is May-August, during which the capacity factor increases to 22-25 %.

35 potential windy wind farm sites have already been identified and wind speed measurements have been carried out. 11 of the sites have been developed for wind farms. Further 45 sites are being monitored for the wind potential. The wind farm areas are found at the coast and further inland. A total wind farm capacity of 4000 MW is considered to be possible in Gujarat.

The present capacity of conventional power supply is 4200 MW. The primary loads are the agriculture, 41 %, and industry, 36 %.

A.2.2 Strategy for wind farm network integration

Initially, the wind farms near Lamba experienced problems due to inadequate capacity of the grid. These problems have been solved and today Gujarat has a strategy for wind farm connection, whereby dedicated 66 kV feeders are connected to a 11/66 kV substation inside the wind farm area. From the 11 kV busbar lines are extended to the 440V/11 kV transformers at the individual wind turbines.

Today, the no-objection-certificate is not issued, unless there is adequate grid capacity available. Until now, reactive power has not been a great concern, and no penalties have been introduced for reactive power consumption.

Load shedding is used during the peak demand periods.

A.2.3 Grid connection procedures and responsibilities

While the 66 kV wind farm feeders are the property and are maintained by Gujarat Electricity Board (GEB), the wind farm 11/66 kV substations are own and operated by Gujarat Energy Development Agency (GEDA). In some cases GEDA has been responsible for the construction of the 66 kV feeder following GEB's specifications.

The grid to the wind turbines from the 11 kV busbar is the responsibility of the investors.

In case of interest in installation of a wind farm, the investor must contact GEDA, who is responsible for development of wind farm sites on government land. GEDA can assist in the full process all the way to commissioning of the wind farm. GEDA's fee for providing power evacuation is 25 lakhs/MW (25,00,000 Rs /MW).

Prior to operation the electrical safety is inspected by an independent government party.

A.2.4 Grid characteristics

The nominal grid frequency is 50 Hz and may vary between 48 and 51 Hz.

The voltage is fairly constant, but during high demand the voltage may drop from 66 kV to 58 kV. On the 11 kV level, voltage variations of 4 % have been observed.

During load shedding periods relatively rare voltage variations of 205-260V are observed on distribution lines, and 6V line to line variations are seen.

In general, GEB provides reactive power compensation at the 11/66 kV substations. Until now, reactive power compensation has not been mounted on the GEDA wind farm power stations. As the wind farm penetration in the Gujarat power system is small, this has not yet been a problem.

Some wind turbines have compensation and even export reactive power to the grid. GEB is cautious about overcompensation because of possible stability problems.

GEB requires a power factor of 0.9 for loads on the grid.

A.2.5 Other observations

At the coastal sites transformers and conductors have experienced severe corrosion due to salinity and need to be replaced after 10 years.

The peak wind production months are from June to August with the high demand months being September to May.

A.3 Maharashtra

A.3.1 General

The state of Maharashtra presently has an installed wind turbine capacity of 15 MW but with policies and incentives to attract a considerable additional capacity during the present 5-year plan. 18 potential windy wind farm sites have already been identified and wind speed measurements have been carried out, showing annual average wind speed above 18 km/h (5 m/s) in 30 m height with the best site having an annual average of 23.3 km/h (6.5 m/s) with wind power intensities of 150-310 W/m². These are estimated to have a potential of 500 MW installed wind turbine capacity. Other sites are being studied, and a total of 1000 MW wind farms are considered feasible in Maharashtra. The sites are found in the western and the north-eastern parts of the state.

The present capacity of conventional power supply is 12,300 MW with a peak demand of 9,300 MW during summer. Another 6,200 MW is expected to be added during the next 5 years.

Wind farms with a total capacity of 100 MW are under study. Application for private wind farms of 50 MW are being considered, and 25 MW is expected to be installed by March 1999.

A.3.2 Strategy for wind farm network integration

To secure power quality a strategy has been adopted for connection of wind farms on the 33 kV level using dedicated feeders from the main grid substations (33/132 kV). Connection to distribution lines with consumers is not allowed. For larger wind farms, e.g. 70 MW, a dedicated 132 kV line is anticipated. The feeder line to the wind farm site is terminated in a substation in the wind farm with a 33 kV busbar for connection of the wind turbines.

Sites are developed, where a total capacity of 10 MW is feasible, and where approach road and grid is available.

Maharashtra State Electricity Board (MSEB) requires industrial consumer to maintain a power factor of 0.9. For wind farms there is no penalty for reactive power consumption. When wind farms provide a larger share of the generating capacity in the future, a penalty may be introduced.

Load shedding is used during the peak demand periods. However, there is no significant voltage unbalance at the point of connection of the dedicated lines from wind farms to the main substation.

A.3.3 Grid connection procedures and responsibilities

Maharashtra Energy Development Agency (MEDA), who together with IITM, in Bangalore carries out the wind monitoring, identifies the wind farm sites. The site is developed by MEDA, who is also responsible for construction and maintenance of roads. MSEB is responsible for bringing the feeder line to the site and constructs and maintains the line ending in the 33 kV busbar at the site.

The developer is charged 20 lakhs (20,00,000 Rs) per MW installed wind turbine capacity to cover the cost of the feeder line and access roads. Switch-gear, line from the common busbar, breakers (required for more than 3 MW capacity) and further step-down transformers is the developers responsibility, and the cost will be borne by the developer.

A.3.4 Grid characteristics

The grid availability in Maharashtra is more than 90 %. The nominal grid frequency is 50 Hz and may vary between 47.5 and 51.5 Hz with a nominal range of -2 to 1 Hz.

The voltage variation at the 33 kV level is ± 10 %. The voltage asymmetry in the main substations is reported to be negligible.

12.5 % current asymmetry may be assumed within the wind farm for design.

MSEB maintains a power factor of 0.9 and has installed capacitor-banks at substations to secure the level.

1.5 % total harmonic distortion is reported for the high voltage side of substations. A similar limit is applicable for the wind farm 33 kV busbar.

A.3.5 Other observations

MSEB reports that wind turbine blades have been damaged by lightning in the coastal areas. Supplementary blade lightning protection, as is common in most new wind turbines, should be used.

The main wind season is in June-August which does not coincide with the period of largest demand of March-April. There is strong interest in low-wind machine with cut-in wind speed of approximately 2.5 m/s.

A.4 Tamil Nadu

A.4.1 General

The state of Tamil Nadu presently has an installed wind turbine capacity of 700 MW in the private sector and 20 MW as government demonstration projects. The wind farms are primarily located in the Muppandal and the Coimbatore areas. The growth of wind farm capacity is expected to be of the order of 100 MW/year the next 5 years.

Annual average wind speeds of 18-20 km/h are found, and the wind season starts in March and continues until November. Annual capacity factors of 20-22 % have been observed.

The present capacity of conventional power supply is 6800 MW from thermal, nuclear and hydro power stations. The power system is connected to the other three states in the Southern region through 400 kV lines.

A.4.2 Strategy for wind farm network integration

The wind farms in Tamil Nadu are installed on private lands. Tamil Nadu Electricity Board (TNEB) has seldom been given an adequate notice to strengthen the grid for new wind farm installations. In some cases it has been necessary to connect new wind farms to existing (overloaded) lines and to restrict the production hours. Thus TNEB has allowed overloading to the limit of the overcurrent protection.

The TNEB strategy for the evacuation feeders is to keep the voltage on the 110 kV level and not to allow loads connected to the wind farm feeders. Substation with voltages of 33 kV, 22 kV and 11 kV are used for connection of the wind turbine step-up transformers. The capacity of the power evacuation lines is slightly less than the capacity of the wind farms.

In the Muppandal area the wind farm 11 or 33 kV substations are connected to a 110 kV main ring line, which again is connected to a 230 kV main transmission line. The 110 kV main ring line also connects other power station and consumer loads. 3 wind farm substations are connected to a 110 kV radial feeder from Kayathar. The transformer capacity is 488 MW, which is slightly more than the present installed wind turbine capacity of 427 MW. The substa-

tions are prepared for additional transformer, and the potential determined by grid line capacity and land is an additional 260 MW wind farms in the area.

TNEB requires an average power factor of 0.85 from the wind turbines and recommends installation of capacitor banks rated as 50 % of the wind turbine active power capacity. If smaller power factors are found, e.g. 0.7, a penalty of 0.1 Rs/kvarh reactive energy will be given after a warning.

In order to correct the power factor TNEB has installed capacitor banks in substations (1000 MVA on 110 kV level and 300 MVA on lower levels) and plans to increase the capacity of these banks.

The rural loads connected to the Muppandal main ring line have a power factor of 0.8. This means that even with full compensation of the wind farm reactive power demands, considerable amounts of reactive power must be supplied from the other power stations and transmitted through the main transmission lines.

A.4.3 Grid connection procedures and responsibilities

The energy development agency's (TEDA's) role is in Tamil Nadu to carry out the wind monitoring and general support. Since most wind farms are installed on private land, neither provision of land nor grid connection is carried out by TEDA.

Having obtained the necessary land the developer applies for a No-objection-certificate (NOC) from TNEB. Having reviewed the wind farm configuration (TNEB requires a spacing of 5 rotor diameter perpendicular to the prevailing wind direction and 7 diameters in the wind direction) and ensured that grid capacity is sufficient, TNEB issues the certificate, and the developer can procure and install his wind turbines.

TNEB has installed 11 or 33 kV substations which are connected to the main 110 kV ring line. The developer must finance and install the 11 (or 33) kV feeder from the substation to his wind farm or wind turbine metering point, following the specifications from TNEB. After installation TNEB takes over the responsibility and the maintenance of the feeder line to the metering point. All internal lines and step-up transformers are the developers responsibility.

A.4.4 Grid characteristics

The normal grid frequency is 48.5 HZ and varies between 47.8 HZ (where the wind turbines disconnect) and 50 Hz. The voltage range at the wind turbine terminals is -15 % to 5 %, while 6-8 % variation on the 11 kV level is allowed by TNEB. The primary cause of voltage tripping of the wind turbines is under-voltage, and the settings are thus -13-+8 % voltage variation. No voltage unbalance for the dedicated wind farm feeders is reported.

TNEB has requirements for the power factor for large industrial users and demands payment for the drawn reactive power.

The grid availability for the dedicated wind farm feeders during peak production is in the range of 95-96 % with an annual average of 98 %.

A.4.5 Other observations

It is expected that the central power station can deliver 15 % more energy if the reactive power drawn from the grid is compensated. The reason is that the rating of the power station generators is inadequate and that the possible active power is reduced at low power factors.

For many wind turbines the reliability of compensation capacitors has been poor with lifetime of the batter capacitor makes of 3 years. A reason is the frequent switching due to fluctuating wind around the cut-in as well as high temperature. The temperatures have for some wind turbines caused controller problems, resulting in further tripping and switching of the capacitors.

Appendix B Parameters for simulation model

Parameters for the induction generator equivalent:

Rated power P_n :	225 kW
Reactive power at no load:	96 kvar
Power factor ($\cos \varphi$) at P_n :	0.81
Rated torque:	2170 Nm
Frequency:	50 Hz
Number of poles:	6

Stator resistance R_1 :	0.019 Ω
Stator reactance X_1 :	0.18 Ω
Rotor resistance R_2' :	0.019 Ω
Rotor reactance X_2' :	0.345 Ω
Iron losses R_m :	180 Ω
Magnetising reactance X_m :	4.8 Ω
Phase to phase voltage U :	400 V

Parameters for the mechanical system:

Rotor inertia (low speed side):	66000 kgm^2
Generator and brake inertia (high speed side):	10 kgm^2
Torsional stiffness:	$5.1 \cdot 10^6$ Nm/rad
Gear ratio:	23.4
Losses in the main bearings:	2.3 kW
Losses in the gear:	7 kW
Mechanical losses in the generator:	1000 W

Title and authors

Power Quality and Integration of Wind Farms in Weak Grids in India

Poul Sørensen, Peter Hauge Madsen, Anders Vikkelsø, K. Kølback Jensen, K.A. Fathima, A.K.Unnikrishnan and Z.V. Lakaparampil

ISBN		ISSN	
87-550-2676-1, 87-550-2678-8 (Internet)		0106-2840	
Department or group		Date	
Wind Energy and Atmospheric Physics		April 2000	
Groups own reg. number(s)		Project/contract No(s)	
1115 015-00		ENS-1363/98-0024	
Pages	Tables	Illustrations	References
66	7	44	15

Abstract (max. 2000 characters)

This is the final report of a joint Danish and Indian project "Power Quality and Integration of Wind Farms in Weak Grids". The power quality issues have been studied and analysed with the Indian conditions as a case. On the basis of meetings with Danish wind turbine industry, Indian electricity boards, nodal agencies, wind turbine industry and authorities, the critical power quality aspects in India have been identified. Measurements on selected wind farms and wind turbines have quantified the power quality, and analyses of power quality issues, especially reactive power compensation, have been performed. Based on measurements and analyses, preliminary recommendations for grid integration of wind turbines in weak grids have been formulated.

Descriptors INIS/EDB

Available on request from Information Service Department, Risø National Laboratory,
(Afdelingen for Informationsservice, Forskningscenter Risø), P.O.Box 49, DK-4000 Roskilde, Denmark.
Telephone +45 4677 4004, Telefax +45 4677 4013