

REUSABLE ALKALINE™ BATTERY SYSTEM FROM RAYOVAC (RENEWAL®)

U. Sengupta, S. Megahed, A. Homa, S. Ruth
Rayovac Corporation
601 Rayovac Drive
Madison WI 53711

■ ABSTRACT

The Rayovac Corporation successfully introduced the Rechargeable Alkaline Manganese-Zinc (RAM) System for consumer applications in the fall of 1993 in four conventional cell sizes (AA, AAA, C, D). The RAM battery is being consumer marketed as a reusable alkaline battery system under the trademark Renewal®. It is being targeted toward all types of applications where primary alkaline are presently used. In addition to consumer replaceability of the Renewal battery, several questions were raised by designers of portable battery-operated equipment regarding battery-charger characteristics for future design-in of this new chemistry. This paper will address these questions and will point the major advantages and disadvantages of the Renewal batteries as compared to nickel-based batteries (e.g., Nickel/Cadmium, Nickel/Metal Hydride).

■ INTRODUCTION

The *RENEWAL*® Reusable Alkaline™ Battery System represents a new alternative for the designer of portable battery-operated equipment. Prior to the introduction of the Renewal product family, most portable equipment was constrained to use either single-use disposable Alkaline batteries or rechargeable battery systems such as Nickel-Cadmium (NiCd) or Nickel-Metal Hydride (NiMH). Renewal can be thought of as "bridging the gap" between the single-use primary alkaline and the traditional choices in rechargeable battery systems. It combines many of the benefits of both conventional alkaline and rechargeable Nickel-based systems.

Renewal can provide an excellent solution for many battery-operated products when one considers all of the various design trade-offs such as cost, battery run-time, storage characteristics and environmental impact. However, the electronic system designer should understand that the Renewal battery may not be the best choice for all applications. For this reason, the following selection criteria, electrical performance and charging method will explain those applications where the Renewal battery is best utilized.

■ BATTERY SELECTION CRITERIA

Primary alkaline batteries are designed for a single discharge only. They have very good energy density when operated at moderate to low discharge rates (typically less than a few hundred milliamperes to one ampere drain rates) and have excellent charge retention

during storage. Attempting to recharge these batteries may result in internal short-circuits between the anode and cathode, internal gas generation and probable leakage. Both primary and reusable Alkaline batteries can be safely disposed of in landfills with no toxic material concerns.

NiCd and NiMH batteries can be recharged and reused many times. They have a very low internal resistance, allowing them to be used for high drain rate discharges up to several amps. They are generally the battery system of choice for relatively high-power portable devices such as power tools, notebook computers, etc. However, their capacity for a single discharge cycle at low to moderate rates in products such as portable audio equipment, palmtop computers, electronic games and toys, or other handheld equipment can be substantially less than that of primary alkalines. Additionally, they tend to have poor shelf life and require recharging before each use if the time between uses is long (days or months, depending on storage conditions).

Finally, NiCd batteries contain Cadmium and require special handling for disposal or recycling. NiMH batteries are perhaps less objectionable environmentally than the NiCd cells but may still be subject to local environmental regulations in some areas. NiMH batteries also have a noticeably higher self-discharge characteristic and are more expensive than NiCd batteries.

Renewal Reusable Alkaline batteries combine some of the characteristics of conventional Alkaline and rechargeable Nickel-based battery products. They have a higher initial capacity than NiCd/NiMH cells, but not as high as primary alkaline. Unlike primary alkaline, they can be recharged and reused, but not for as many cycles as NiCd/NiMH.

The reason for increased capacity, but not drain rate, of primary alkaline and the Renewal battery as compared to NiCd/NiMH is attributed to electrode design. Primary alkaline and Renewal electrodes (bobbin-type) have higher packing density but lower surface area than those of NiCd/NiMH (spiral-wound). The former also is lower in manufacturing cost than the latter due to a simpler and more efficient manufacturing method.

a) Renewal versus Primary Alkaline

Renewal Reusable Alkalines are generally interchangeable with primary alkaline batteries. However, they do have a slightly higher internal resistance characteristic than primary alkaline batteries. Because of

this, Renewal batteries may exhibit lower performance when compared to primary alkalines in applications that require high continuous or pulse current loads.

At low and moderate drain rates (where the effect of the internal resistance in the Renewal battery is less significant), the performance of Renewal can be close to that of primary alkalines. The general operation, discharge curve shape, and storage (charge retention) characteristics of Renewal and primary alkaline batteries are very similar.

The advantage of Renewal batteries over primary alkalines is the reusability of the Renewal system. Renewal batteries can be recharged because they have different internal construction and chemical composition than conventional alkalines.

While the performance of a Renewal cell on a single discharge cycle may be less than that of a primary alkaline, the rechargeability of the Renewal system allows a single cell to provide a cumulative capacity equivalent to dozens of single-use cells.

Over a period of several charge/discharge cycles Renewal batteries can represent a significant cost savings to the end user over single-use disposable alkaline batteries. Renewal also presents a more environmentally responsible alternative to the large number of primary alkaline batteries that would require disposal over time when used throughout the lifetime of a given electronic product.

b) Renewal versus NiCd and NiMH

NiCd and NiMH batteries generally provide a good solution for applications requiring high rate discharge or very frequent charge / discharge cycles. However, these

batteries are relatively expensive and have very poor shelf life characteristics. Additionally, they have relatively low energy density in comparison with alkalines at low or moderate drain rates, a lower terminal voltage (which may be relevant for low-power single-cell or two-cell applications that have very little margin or voltage range to work with) and are subject to environmental restrictions regarding collection and recycling at end of life.

Renewal provides an alternative which may have both lower cost and better performance for products with low or moderate drain levels or intermittent usage patterns. The advantages of Renewal compared to the Nickel-based systems are summarized below.

- Battery operated equipment can run longer between recharges due to higher capacity of the Renewal batteries
- Renewal batteries come in standard sizes and can be used in multiple devices (unlike custom-designed battery packs which are unique to a specific product)
- Renewal eliminates the need for the user to manage battery usage patterns... it does not require full discharge before recharge, has no memory effect, negligible self-discharge, etc.
- Easily and inexpensively replaced by consumers when new batteries are needed
- Environmentally responsible
- Substantially better shelf life (5+ years in storage)
- Lower initial cost of cells results in lower product cost
- Low-battery warning circuitry can be simpler due to shape of Alkaline cell discharge curve

Table 1 compares Renewal with NiCd and NiMH at nominal loads (approximately 150 mA) and temperature (approximately 20°C) using the AA-cell size as a test vehicle. The table shows the capacity and cost advantages of Renewal over nickel-based systems.

TABLE 1: COMPARISON OF RENEWAL WITH NiCd AND NiMH EXAMPLE: AA-CELL (APPROXIMATE VALUES)

	RENEWAL	NiCd*	NiMH*
Nominal Capacity, mAh (varies with load)	1400 initial, 700 after 25 cycles	750	1100
Usable Cycles (varies with discharge level)	25+	200+	300+
Nominal Voltage Range (under load)	0.9 to 1.4	1.0 to 1.3	1.0 to 1.3
Weight	22g	22g	26g
Gravimetric Energy Density (watt-hr/kg)	80 (initial)	41	51
Volumetric Energy Density (watt-hr/liter)	220 (initial)	115	170
Continuous Output Current (max. recommended)	400 mA	>5A	>4A
Peak Output Current	1A	>10A	>10A
Fast Charge Time	2-3 Hrs	1 Hr	1 Hr
Self-Discharge Rate (room temperature)	0.01% per day	1% per day	4% per day
Typical OEM Cost Per Cell	\$0.50	\$1.25	\$3
Typical Retail Replacement Cost (4-cell pack)	\$5	\$10-\$30	\$60+
Safely Disposable	Yes	No	???

*NiCd/NiMH capacity and weight data was taken from Energizer Ultramax and Hydritech Data Sheets. Other parameters are estimates or calculations based on typical values and may not be exact.

■ ELECTRICAL PERFORMANCE DATA (AA-SIZE)

Data on operating voltage, cycle life and recharge time for the AA Renewal cell is presented below. Similar data on other sizes (AAA, C, D) are available upon request from Rayovac.

a) Operating Voltage/Capacity

Figures 1.a. and 1.b. show the voltage profile for constant current discharge (20-400 mA/cell) of AA Renewal cell to a cut-off voltage of 0.9 volt. Increasing the discharge current resulted in lower capacity and efficiency due to cell polarization - a phenomenon common to all batteries. Cell capacity and discharge efficiency is shown in Table 2.

Current Load (mA)	Discharge Time (Hrs)	AA Capacity (mAh/Cell)	Efficiency
20	90.0	1800	100%
50	36.0	1800	100%
100	16.0	1600	89%
200	6.15	1230	68%
300	3.45	1035	58%
400	2.25	900	50%

Table 2.

The taper discharge curves in Figure 1.a. and 1.b. represent initial cell capacity (that is, the capacity for a new cell on its first discharge cycle). Figures 2.a, 2.b. and 2.c. show the effect of charge/discharge cycle on cell capacity at specific discharge rates. In each graph, the voltage profiles show the results obtained from the same cell for different discharge cycles at the specified drain rate. Each discharge was terminated when the cell voltage dropped to 0.90 volt.

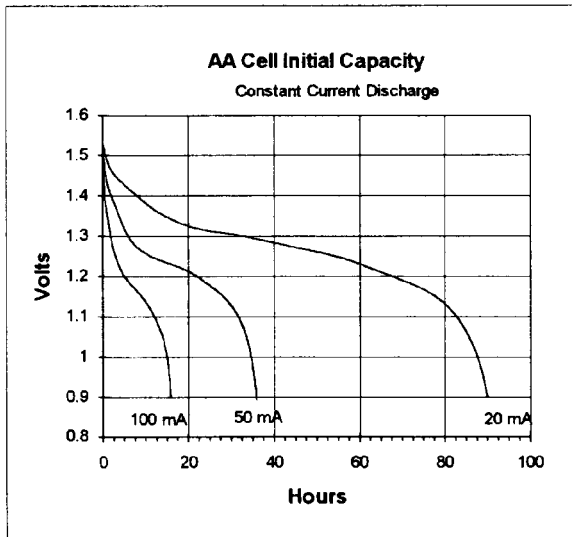

Figure 1a.

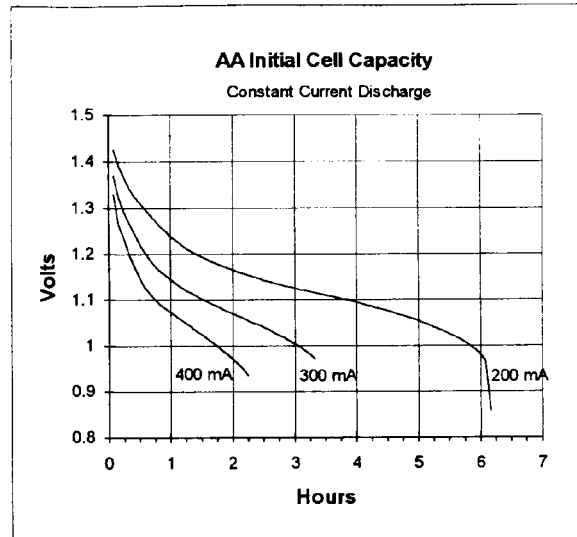

Figure 1b

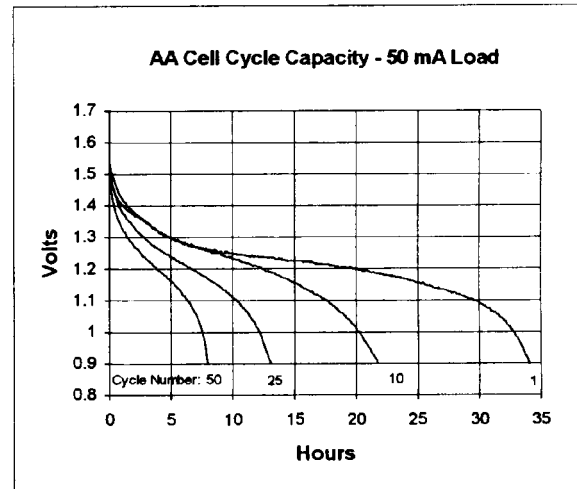

Figure 2a.

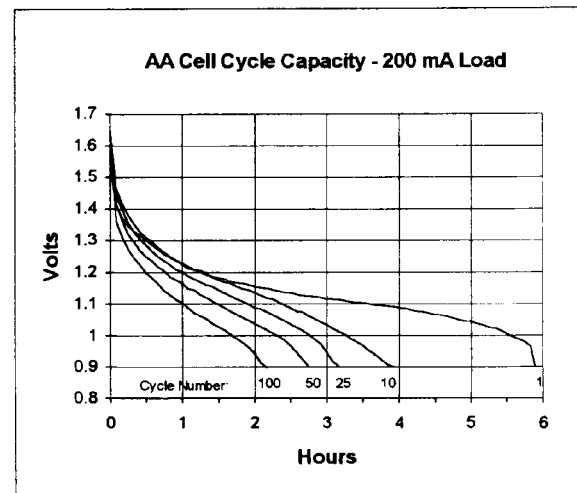

Figure 2b.

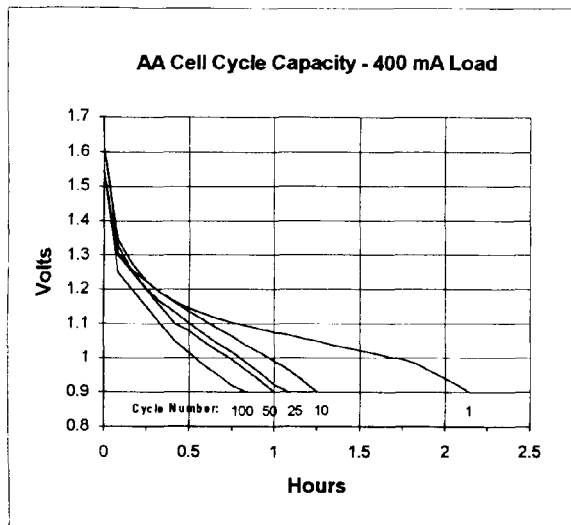

Figure 2c.

b) Cycle Life/Capacity Fade

On each successive discharge cycle, the performance of the Renewal cell will be lower in comparison to the previous cycle. Figure 3 illustrates the loss in capacity from the initial to the 25th discharge cycle at different discharge rates. The batteries can continue to be charged and discharged for additional cycles if desired; the cell performance will continue to diminish accordingly.

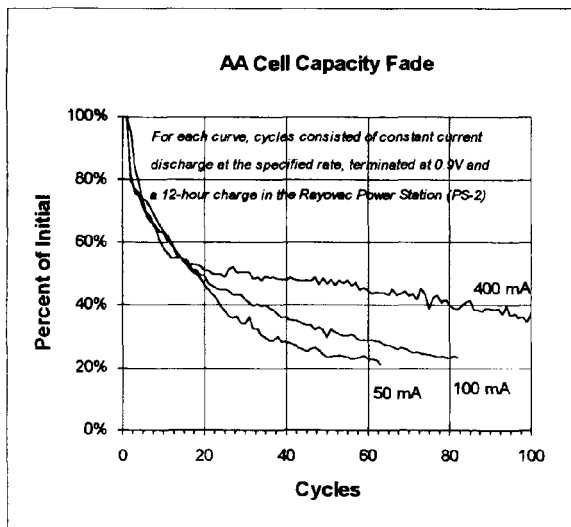

Figure 3.

The degree of this deterioration will not be the same in all applications. It depends on factors such as rate of discharge and the endpoint voltage at which the discharge is terminated. These relate to the "depth of discharge," or the amount of energy withdrawn from the battery prior to recharge for each cycle.

The *depth* of discharge is not the same as the *rate* of discharge. Depth of discharge refers to the total amount

of capacity withdrawn from the battery, while rate of discharge is the level of current being drawn from the cell at a given time.

Figure 4 shows the cumulative capacity obtained over the first 25 cycles at specific discharge rates with each discharge terminated at a cell voltage of 0.9 Volts. While the low rate discharge curves in Figure 3 showed a higher degree of capacity fade than at high rates, it can be seen from Figure 4 that the total capacity delivered is still higher when the cell is discharged at low drain rates to the same endpoint voltage.

The curves in Figure 4 have a decreasing slope as the cycle count increases, which is indicative of diminishing discharge capacity with each successive cycle. However, it can be seen from the positive slope at the end of the graph that there are usable cycles left in the cells. If a battery was at the absolute end-of-life, recharging it would not restore any significant amount of discharge capacity and thus the cumulative capacity would no longer increase with successive cycles. The number of usable cycles in a given application will depend on the point at which the operating time for the batteries in the device falls below a minimum acceptable level.

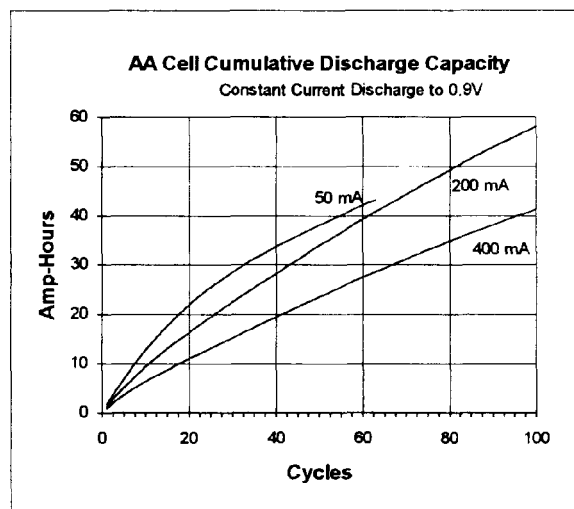

Figure 4.

In summary, applications which have a higher depth of discharge between recharge cycles will see the most pronounced capacity fade. Applications with a very shallow discharge will be able to obtain a greater number of discharge / recharge cycles from Renewal cells because of the reduced level of capacity fade. The standard claim of 25 cycles for Renewal batteries is based on typical or average use in consumer products. For certain applications with shallow discharges and frequent recharges, it is possible to obtain hundreds of usable cycles

c) Recharge Time

Figure 5 shows the time required to restore the AA cell to

a given state of charge after various discharge conditions. The cells were recharged in the PS-2 Power Station after being discharged at different rates to the same endpoint voltage (a more detailed description of the charge method used in the Renewal Power Station is given in the following section).

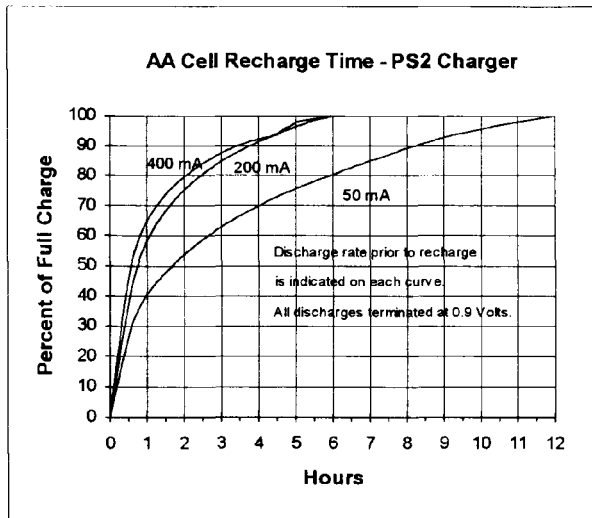

Figure 5.

The illustration shows that if the same peak charge rate is used, the length of time required to reach full charge is higher for the lower-rate discharge case when the endpoint voltage of the discharge is the same. This is because the low-rate cell had a significantly greater depth of discharge (as described in the earlier section on cycle life and capacity fade). Since the cells were all recharged at the same rate, the cells which had been more fully drained required a longer time to be restored to a full state of charge.

For purposes of this illustration, "full charge" is defined as the point when the average charge current delivered to the cell had tapered to a negligibly low value (a few

milliamps or less). This means that the amount of capacity being added to the battery by the charger was asymptotically approaching zero. The LED-out point generally corresponds to a state of 80 to 85% of this level, depending on the discharge condition of the cell.

Recharge times are fairly consistent over the cycle life of the battery as long as the discharge rate and endpoint voltage are kept consistent for each discharge. The data is shown for cycle 10 only as a representative indication.

■ CHARGING METHOD

The Renewal Power Stations implement a special charge method as described below. The present chargers perform the recharge on each cell individually. The characteristics of the Reusable Alkaline system require that the charging of the cells be done on an individual cell basis and not on a series connection of cells.

Many of the standard techniques used with NiCd/NiMH fast chargers such as $-\Delta V/\Delta t$ slope detection, absolute temperature cutoff, or $+\Delta T/\Delta t$ termination are not compatible with Reusable Alkaline batteries. Continuous trickle charging and overcharging as used in many low-cost NiCd chargers is also not acceptable.

Renewal batteries are charged using a pulse charge method. Fixed amplitude, variable duty cycle pulses are applied to the battery during charge. The pulses are limited in amplitude by current-limiting resistors. The duty cycle is modulated by a control chip.

This device is an Application Specific Integrated Circuit, (ASIC) specifically designed for use in the Renewal Power Stations. The average value of the charging current applied to the batteries is gradually reduced as the open-circuit voltage of the battery increases during the charge. The charging mechanism compensates for the internal resistance of the cell by taking the voltage measurement of the cell during the off-time of the charging pulse.

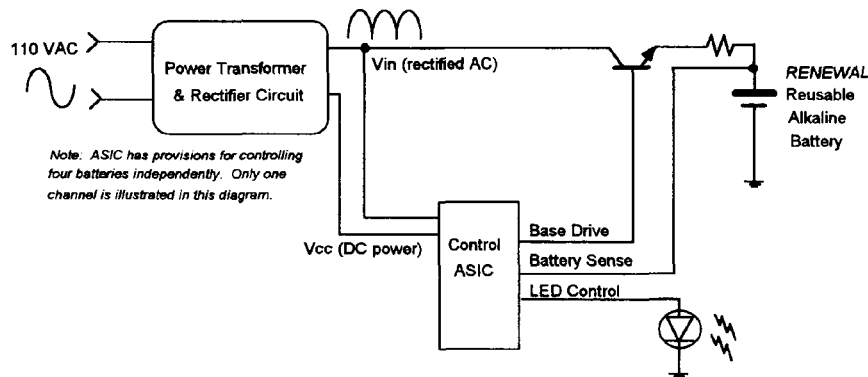

Figure 6. Simplified Block Diagram of the Renewal Power Station

As illustrated in Figure 6, the transformer in the charger has two outputs. The signal labeled "Vin" is a rectified (but not filtered) sine wave which provides 120Hz pulses

at an amplitude of approximately 4 volts peak; the other (designated as Vcc) is a filtered output that provides approximately 8V DC to operate the ASIC and also

provide a positive bias to turn on the NPN pass transistors (via the chip's DRIVE signal). The voltages are taken off the secondary side of a 60Hz transformer and are unregulated, so they will vary somewhat over line and load changes.

The Vin pulses are used for charging the battery. The ASIC monitors the battery voltage during the time when the pulse amplitude is low to get an accurate *open circuit voltage* (OCV) measurement. Monitoring the battery during charge (i.e., when the pulse amplitude is higher than the battery's OCV) will give a higher voltage reading due to the voltage drop across the battery's internal resistance. This is caused by the charge current flowing into the cell.

As the ASIC senses the battery's OCV, it determines how much charge the battery receives by modulating the duty cycle of the base drive signal to the NPN pass transistor. As the OCV of the battery increases, the duty cycle of the DRIVE signal is reduced accordingly, resulting in a tapering average charge current profile towards the end-of-charge. The LED is deactivated when three consecutive charge pulses are disabled (the battery has stayed above the 1.65V reference value for this period of time).

As the battery reaches full charge, the duty cycle of the pulse train continues to decrease (a greater number of consecutive pulses are blocked) causing the average current applied to the battery to taper towards zero. The recharge process is inhibited if the charge control ASIC senses that a battery is in a condition that should not allow recharging, such as an excessively drained battery (below undervoltage limit) or a high-impedance battery (above overvoltage limit when charge current is applied). A typical cell voltage/current profile during the recharge process is shown below in Figure 7.

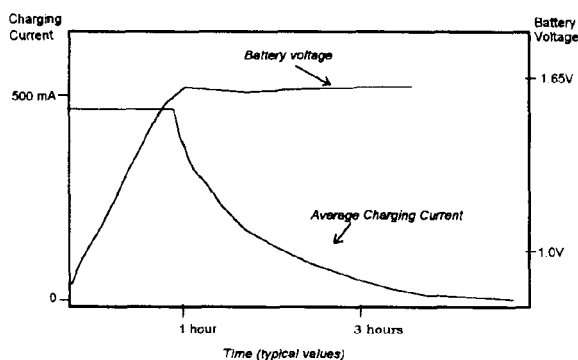

Figure 7.

■ SYSTEM DESIGN CONSIDERATIONS

The performance of Renewal batteries in a given electronic system can be optimized if the system contains circuitry to manage the use of the batteries.

a) Discharge Monitoring

The cycle life of the cells is optimized if they are not excessively discharged. A cutoff voltage of no less than 0.8V per cell is recommended. In particular, cell reversal should be avoided. If multiple cells are connected in series, some cells may be drained more rapidly than others due to mismatches in internal resistance or initial voltage between the cells.

In NiCd/NiMH based systems with cells connected in series, the total voltage of the series string is generally used to indicate a low battery or cutoff condition. In the case of Renewal, the low battery cutoff should occur when any one of the individual cells in the series connection reaches the low-voltage threshold. While this may reduce the operating time for a given discharge cycle (because the operation is effectively terminated when the weakest of all the cells is drained), it will avoid the overdischarge or reversal that may occur if only the overall voltage of the series connection is monitored.

The low-battery warning can be made by a voltage measurement only (it is generally not necessary to attempt to detect the "knee" of discharge by monitoring dV/dt as is often done in NiCd/NiMH systems due to their flat discharge curve). If a prediction of residual capacity is required at a certain voltage point, the circuit should be calibrated for the current level at which that the device is operating as the in-circuit voltage of the batteries will depend on the load current. The threshold for cutoff can be set to a level appropriate for the application based on run-time, load rate, and cycle life requirements.

b) Pulse/Transient Loads

As is observable from the discharge curves in Figures 1 and 2, a cell loaded at 200 mA will last more than twice as long as a cell loaded at 400 mA. Thus, a constant 200 mA load will last longer than a 400 mA load at 50% pulsed duty cycle (even though both load conditions have the same average value).

For example, switch-mode power supplies used for DC/DC conversion in portable products will typically place a discontinuous load on the power source. It is desirable to minimize the input ripple current by using low-ESR, high value input bypass capacitors. This will average the load transients that are applied to the cells and increase the operating time available.

c) Charging System Implementation

OEM developers considering RENEWAL have various options as to the recharging system that they can use. For applications which allow for charging of the batteries outside of the device that uses them, the Rayovac PS-1 and/or PS-2 Power Stations can be used. Alternatively, developers may implement the Renewal charging algorithm into their own equipment either via a charge-control IC as specified by Rayovac from an approved source, or by their own microprocessor-based control device with incorporating the Renewal charge algorithm into the code, or by a hardware implementation providing

the equivalent functionality.

Rayovac can provide circuit diagrams, parts lists, and sources for the unique components in the Rayovac Power Stations to OEMs who wish to incorporate the charging circuitry into their own products. Rayovac may request that OEM developers who wish to implement their own charging system agree to a contract of mutual non-disclosure prior to receiving this information.

d) Storage and Replacement

The storage characteristics of Renewal are generally comparable to primary alkaline batteries. High temperature storage conditions will reduce the shelf life of the batteries and should therefore be avoided if possible. The Renewal cells will retain their capacity best if left in a fully charged state prior to storage.

Circuitry connected to the batteries should not place a continuous load on the cells during periods of storage. This could possibly overdischarge them (this is referred to as a "loaded storage" condition that is considered undesirable for any rechargeable battery system). For example, a resistance placed across the battery terminals as part of a battery monitoring circuit should be disconnected when the device is not in use.

Otherwise, it could eventually discharge the cells below the undervoltage limit of the charger. This will reduce the

rechargeability of the cells.

As with any battery system, when cells are replaced at the end of their useful cycle life, all cells in the device should be replaced simultaneously.

■ SUMMARY

The Renewal Reusable Alkaline Battery System from Rayovac gives the designers of portable battery-operated equipment an excellent opportunity to maximize the benefits of an optimum design. Reviewing the selection criteria, electrical performance and charging method at the beginning of the design cycle will permit the designer to capitalize on the benefits of the Renewal battery (e.g., low cost, environmental responsibility, excellent shelf, etc.). Further assistance can be provided by Rayovac regarding discharge monitoring, pulse/transient loads and charging system implementation. The Renewal system can be thought of as "bridging the gap" between the single-use primary alkaline and the traditional nickel-based systems. This gap can now be properly filled with this new innovation.

Any circuitry associated with the charging of Renewal batteries should be reviewed and approved by Rayovac prior to product release.